

POST

Where there is magic . . .

July 23, 2023

... there must be a magician

Another recent confirmation (https://r20.rs6.net/tn.jsp?f=001p69XCyoK1NDNrAZUv4F6wG9ChyI7WITsJzP_qonHW9yeQoDRr6lPwoGM1d3LlFEbu54LOpGYzGPw7pRy7yoFo6YjWmqORnLObzF_A4Z_3fUmnhhL8rrFNrDqyofkcnnGRBrKHQEGMe2P4A2ueKH9BVImj8NWjejNk25Jx38e79UbwqO4E8BxJQ==&c=&ch=) of the delayed choice quantum erasure experiment ...

**“The world is
magical.”**

- Jed Anderson, EnviroAI



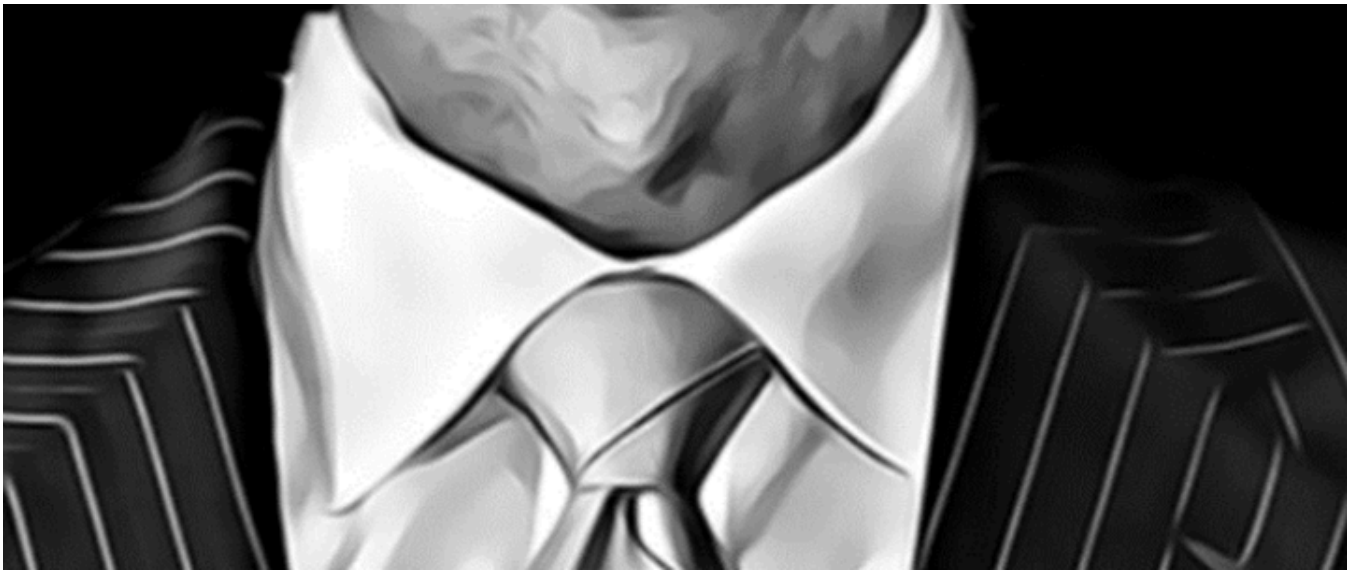

“We will first understand how simple the universe is when we recognize how strange it is.” - John Wheeler

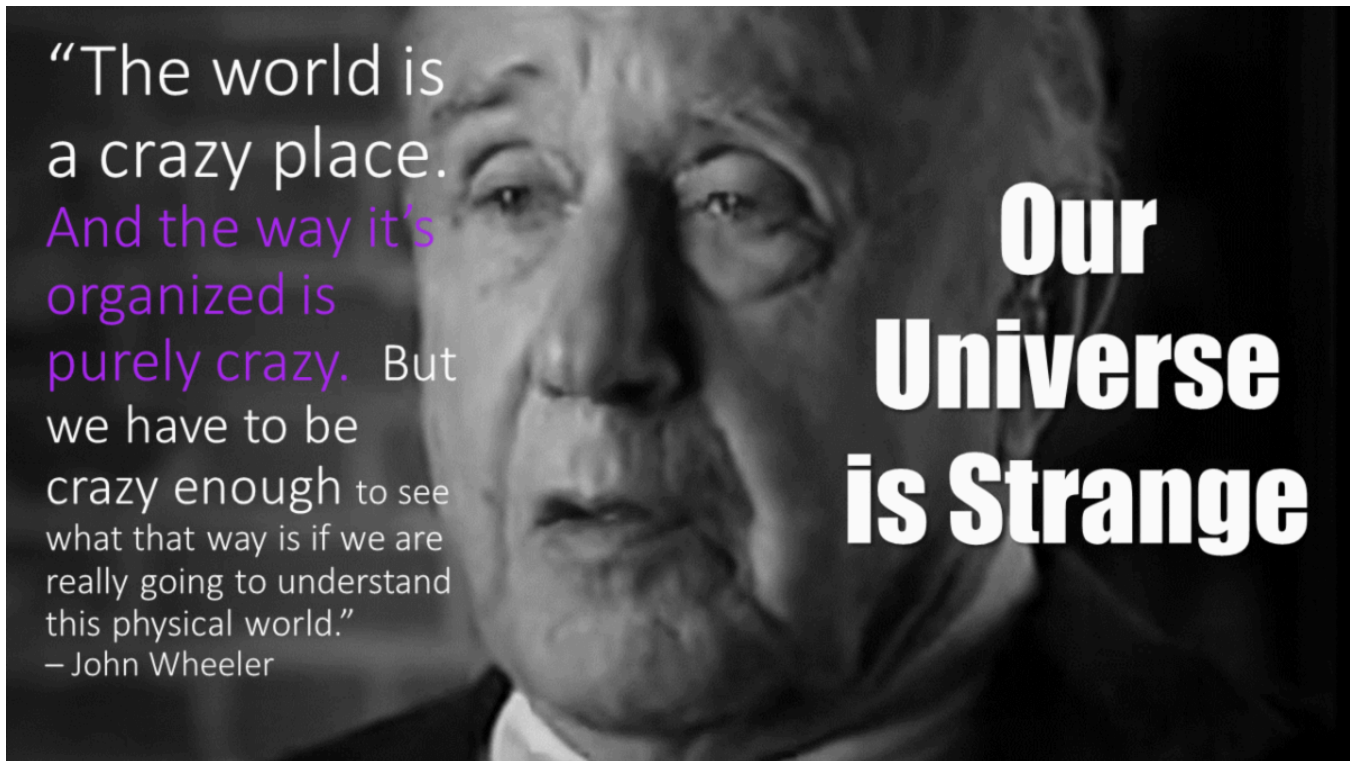

NATURE CRAZY?

OR US NOT CRAZY ENOUGH?

NATURE CRAZY?

OR US NOT CRAZY ENOUGH?

NATURE CRAZY?

OR US NOT CRAZY ENOUGH?

“To nature, the way it works isn’t crazy. It’s normal.”

- Jed Anderson, EnviroAI

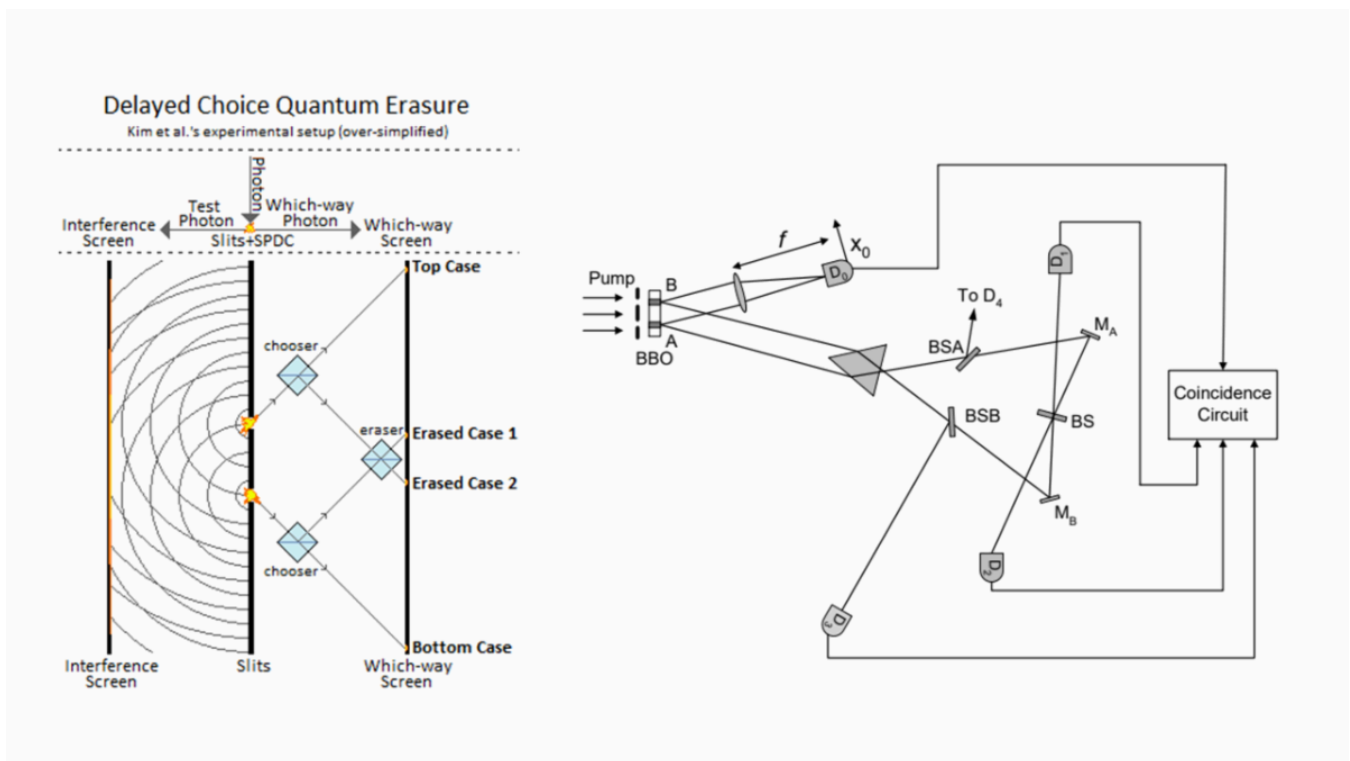

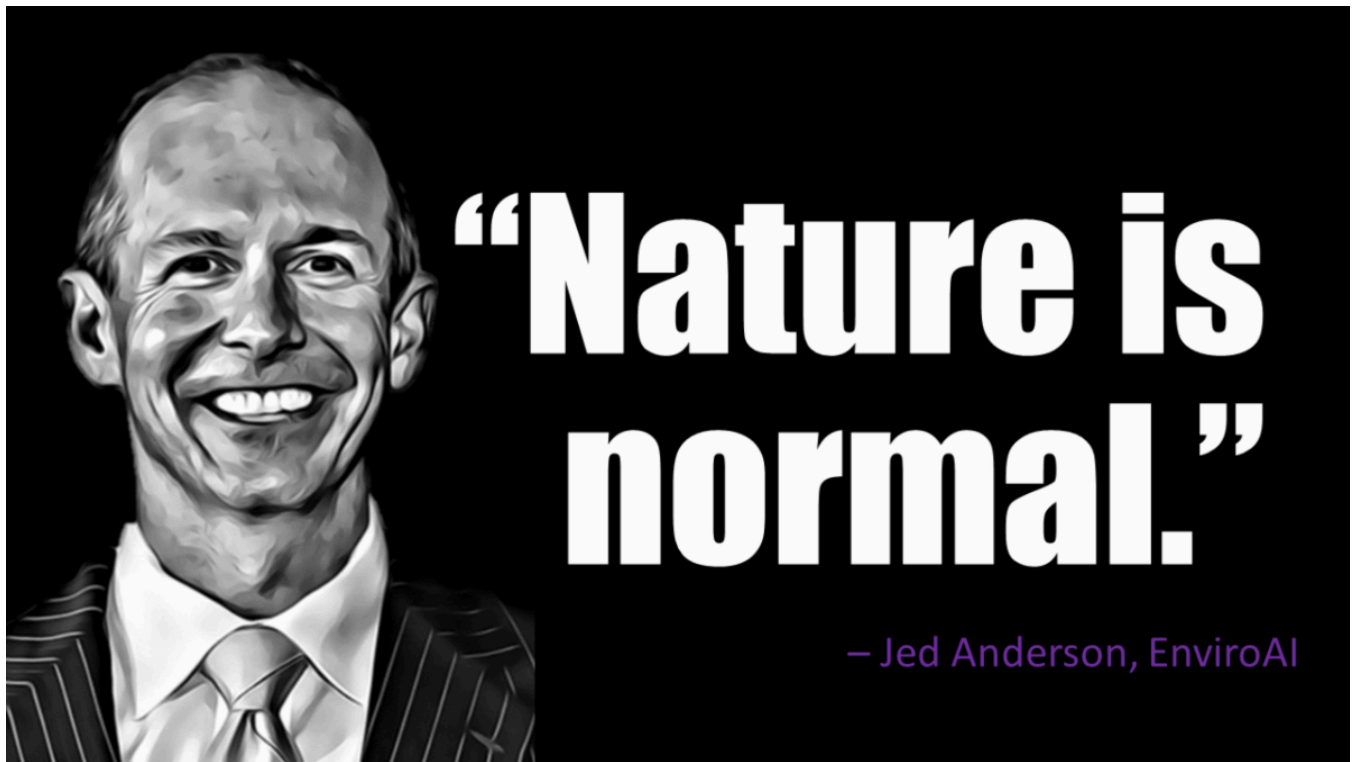

“If anything needs adjustments, it’s our perceptions. Nature is fine. Nature is what it is. It’s always worked this way. I think nature is probably more grounded in truth than our perceptions. Therefore, if anything needs to adjust to what is truth and normalcy ... it’s probably us.”

- Jed Anderson, EnviroAI

NATURE is . . .

CRAZY.

BEAUTIFUL.

SIMPLE.





John Wheeler's accomplishments in physics are dizzying. The man who coined the term "blackhole" and "wormhole." Famous for the expression "it from bit". Princeton Professor who trained Richard Feynman, Hugh Everett, Jacob Beckenstein, and countless other renowned physicists. Involved in the Manhattan Project with Oppenheimer. He has described his career as three evolutionary phases in thinking: 1. Everything is a Particle, 2. Everything is a Field, 3. Everything is Information. During this last phase, Wheeler came up with the "Delayed Choice Experiment". If you want to see how truly strange the universe works, understand this experiment. Here is Wheeler's own description (https://r20.rs6.net/tn.jsp?f=001p69XCyoK1NDNrAZUv4F6wG9ChyI7WlTsJzP_qonHW9yeQoDRr6lPwoGM1d3LlfEBAvUnX6oBVY-BWaq8XoAhYwO8fCbpSWpVpKnLetXfceBoef9ko5KkkusFovgPRoNCepfZ-QI4Uvo1kzaG6PoF3I6VSwUMr-IqomJl5RcuOvsMJLnJrcPiZDl9SfLxZAag7qiUFQ34DcT8Zsf9WgHb8jwxcie2hU-p4MBfUxw-gSy5EhoiM8CfD8b_owTBcBHmSivLCUSoOI=&c=&ch=)). And here is a short tutorial video (https://r20.rs6.net/tn.jsp?f=001p69XCyoK1NDNrAZUv4F6wG9ChyI7WlTsJzP_qonHW9yeQoDRr6lPwoGM1d3LlfEBK9LiR5dgVGS85vT_GFdi-s6_AB53J7t3cBw37WMK9nVdd-hLuagyumQwUrwVE15YvQBExC5fWmVgZizv-IMknA==&c=&ch=)). This is not an easy intellectual-lift, but the reward is well worth the exertion.

Delayed Choice Quantum Erasure

Kim et al.'s experimental setup (over-simplified)

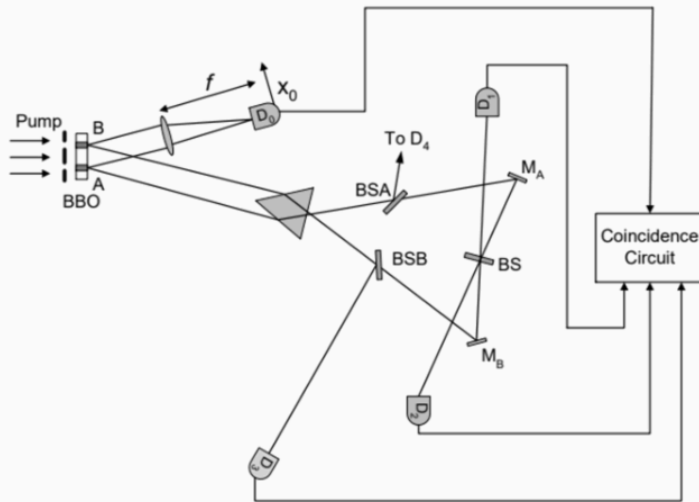
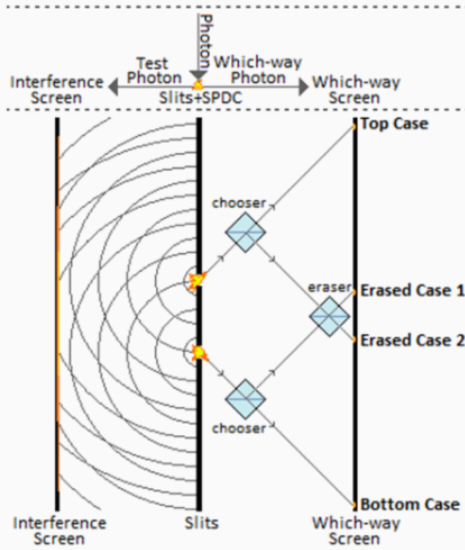

SIMPLE

"We will first understand how **simple** the universe is when we recognize how strange it is." -John Archibald Wheeler

"Behind it all is surely an idea so **simple**, so beautiful, that when we grasp it - in a decade, a century, or a millennium - we will all say to each other, how could it have been otherwise? How could we have been so stupid?"

John Archibald Wheeler

"It is my opinion that everything must be based on a **simple** idea. And it is my opinion that this idea, once we have finally discovered it, will be so compelling, so beautiful, that we will say to one another, yes, how could it have been any different."

John Archibald Wheeler

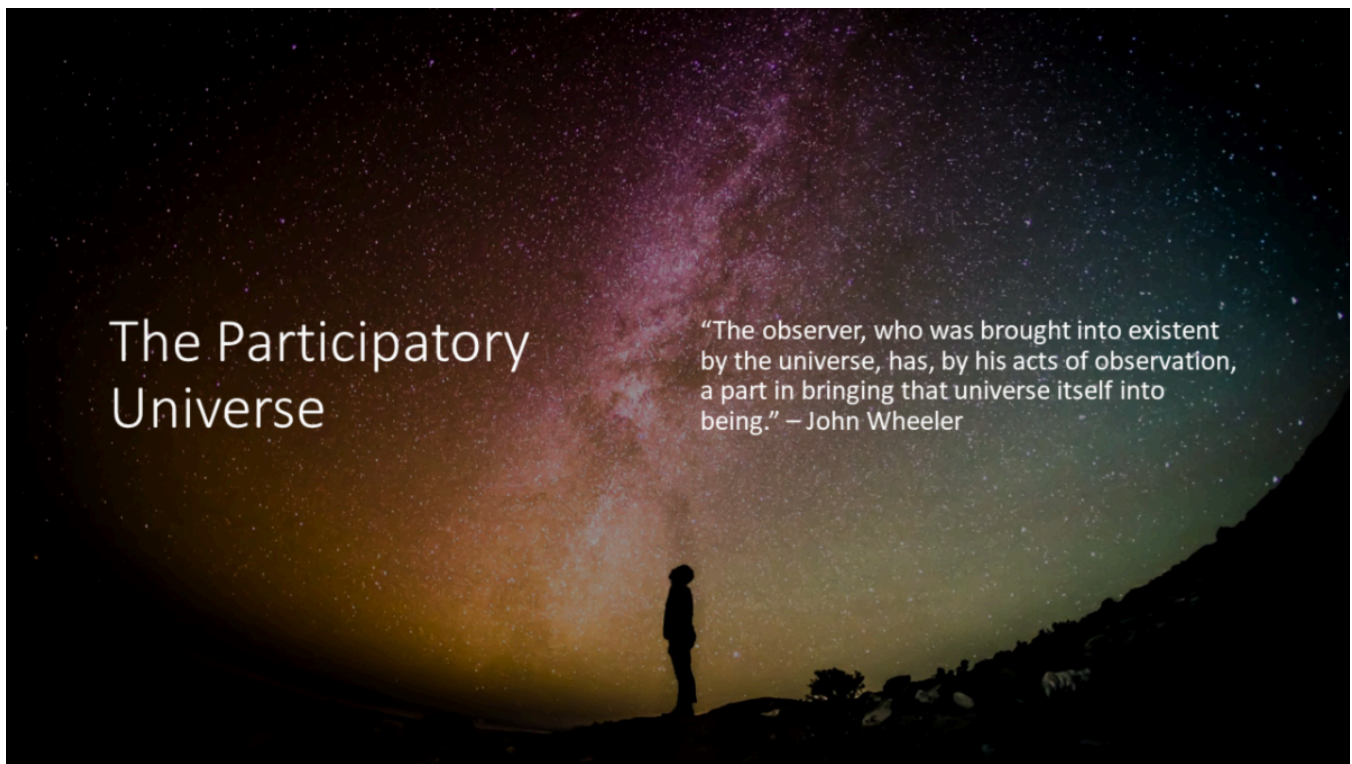

The Participatory Universe

"The observer, who was brought into existence by the universe, has, by his acts of observation, a part in bringing that universe itself into being." – John Wheeler

After you get a sense of the delayed choice quantum erasure experiment, you will love pondering this quote from John Wheeler about what he believes the experiment might be pointing toward: "The observer, who was brought into existence by the universe, has, by his acts of observation, a part in bringing that universe itself into being."

And the quote is even better hearing it from Wheeler himself ([listen to it here](http://r20.rs6.net/tn.jsp?f=001p69XCyoK1NDNrAZUv4F6wG9ChyI7WlTsJzP_qonHW9yeQoDRr6lPwoGM1d3LlfEBV4Ix34sreDLKhgpIe-FUaQ_Nn_Yg3Cot9Bo-3lmz18yV64bg4SGdxD9US1FXp4-7zqofcgIs7QlBkh9S6jELiQ==&c=&ch=)) (http://r20.rs6.net/tn.jsp?f=001p69XCyoK1NDNrAZUv4F6wG9ChyI7WlTsJzP_qonHW9yeQoDRr6lPwoGM1d3LlfEBV4Ix34sreDLKhgpIe-FUaQ_Nn_Yg3Cot9Bo-3lmz18yV64bg4SGdxD9US1FXp4-7zqofcgIs7QlBkh9S6jELiQ==&c=&ch=))).

This quote will keep you thinking for hours and hours.

"[The observer]" has a part in bringing the universe itself into being" - John Wheeler

Fascinating thinking!

Fascinating to think about!

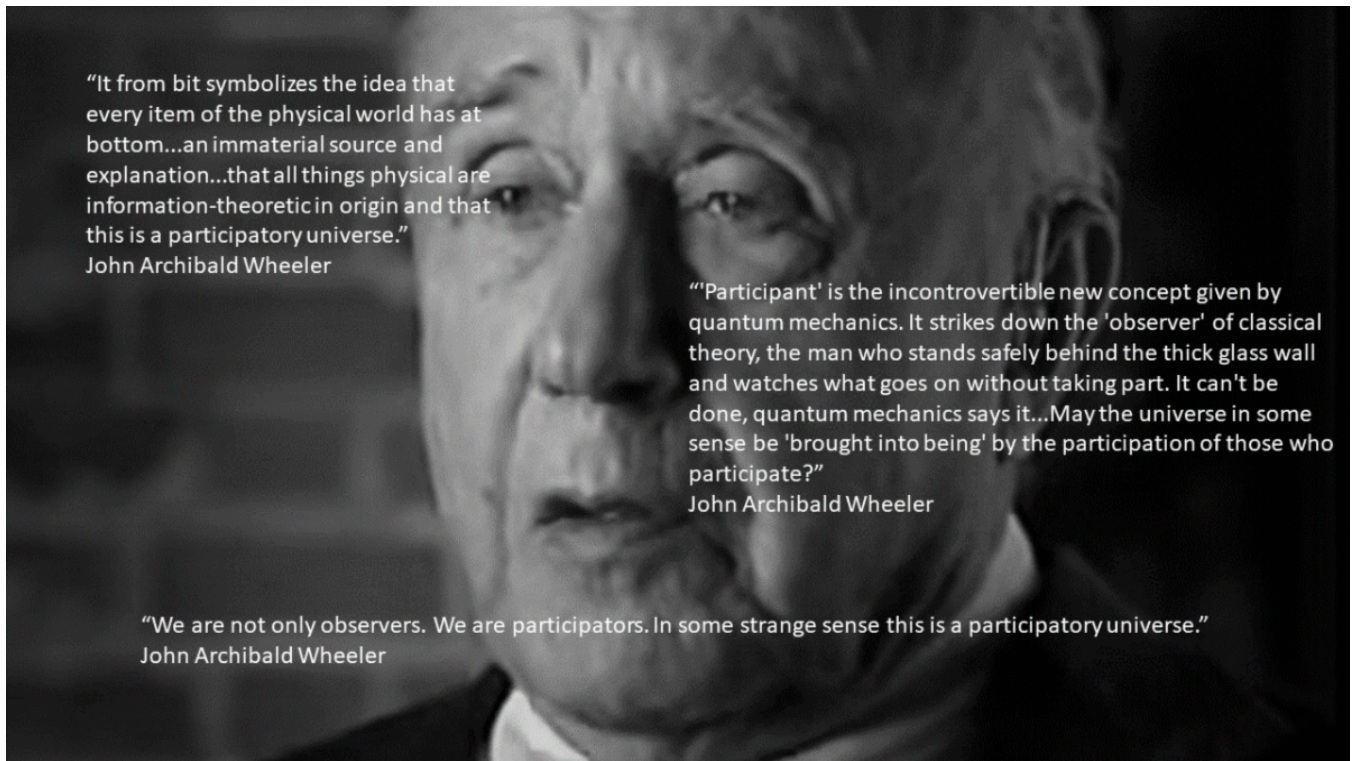
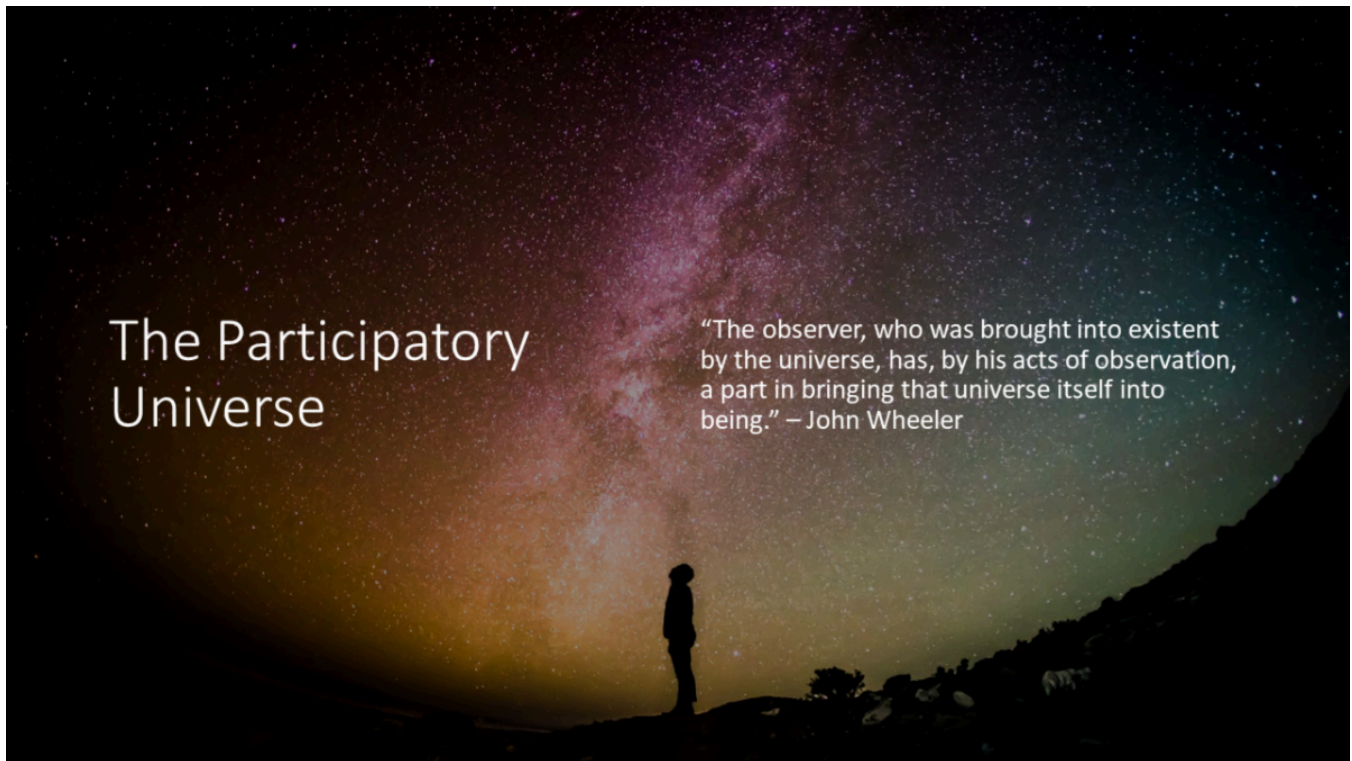

The Participatory Universe?

Increasing the Scope of Our Participatory Observations in the Universe

PERCEPTION OF PHENOMENA



“Nothing in life is to be feared. It is only to be understood.”

—Marie Curie

GOING BEYOND IMMEDIATE PERCEPTION

How much can we perceive?

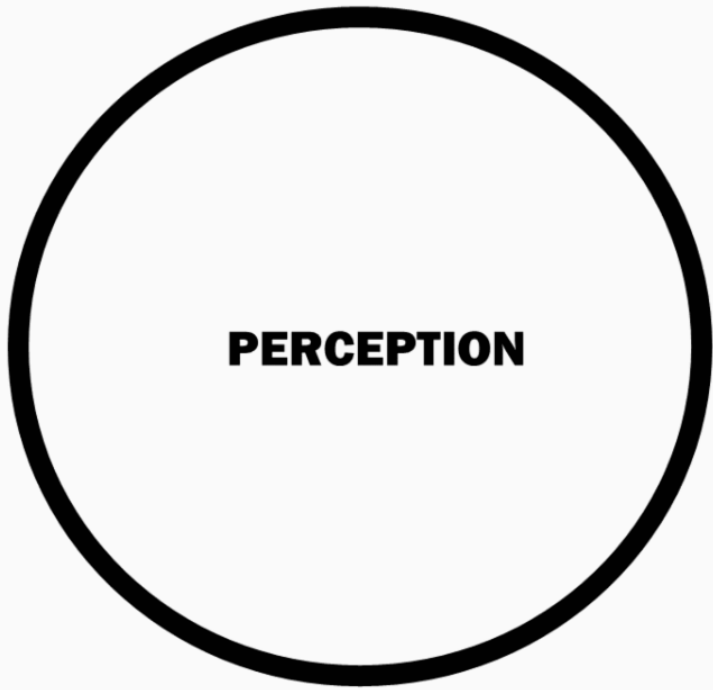

INCREASE WHAT WE PERCEIVE AROUND US

“More perceptivity . . .
more reality.”

“The world is
full of magic
things, patiently
waiting for our

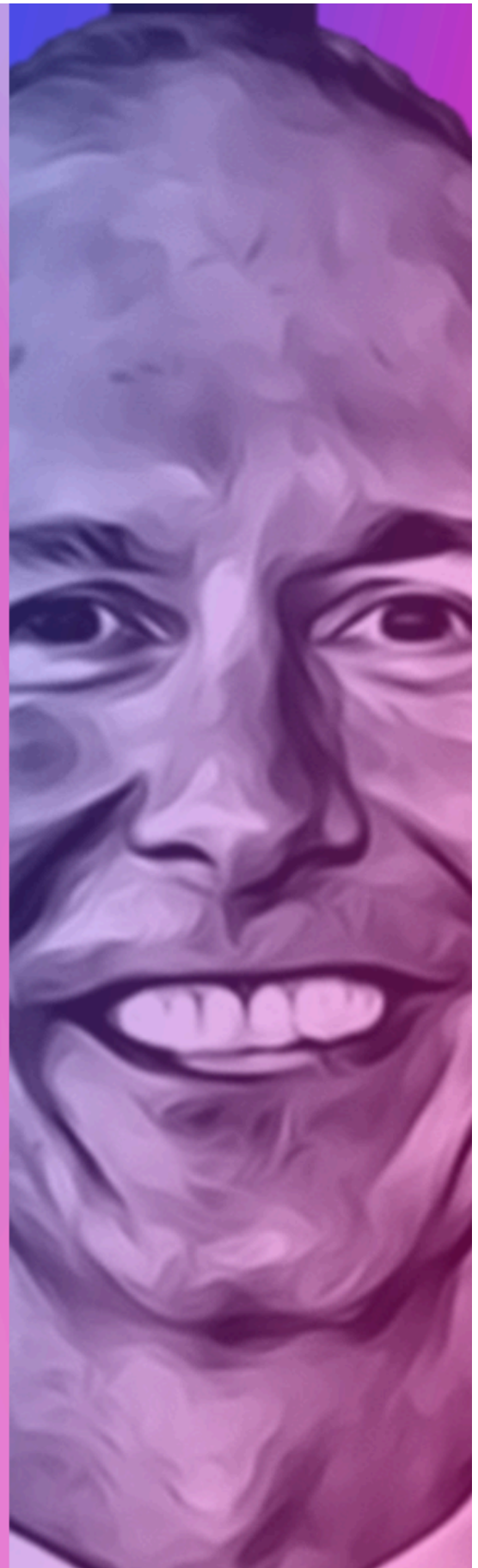

senses to grow
sharper.”
— W.B. Yeats

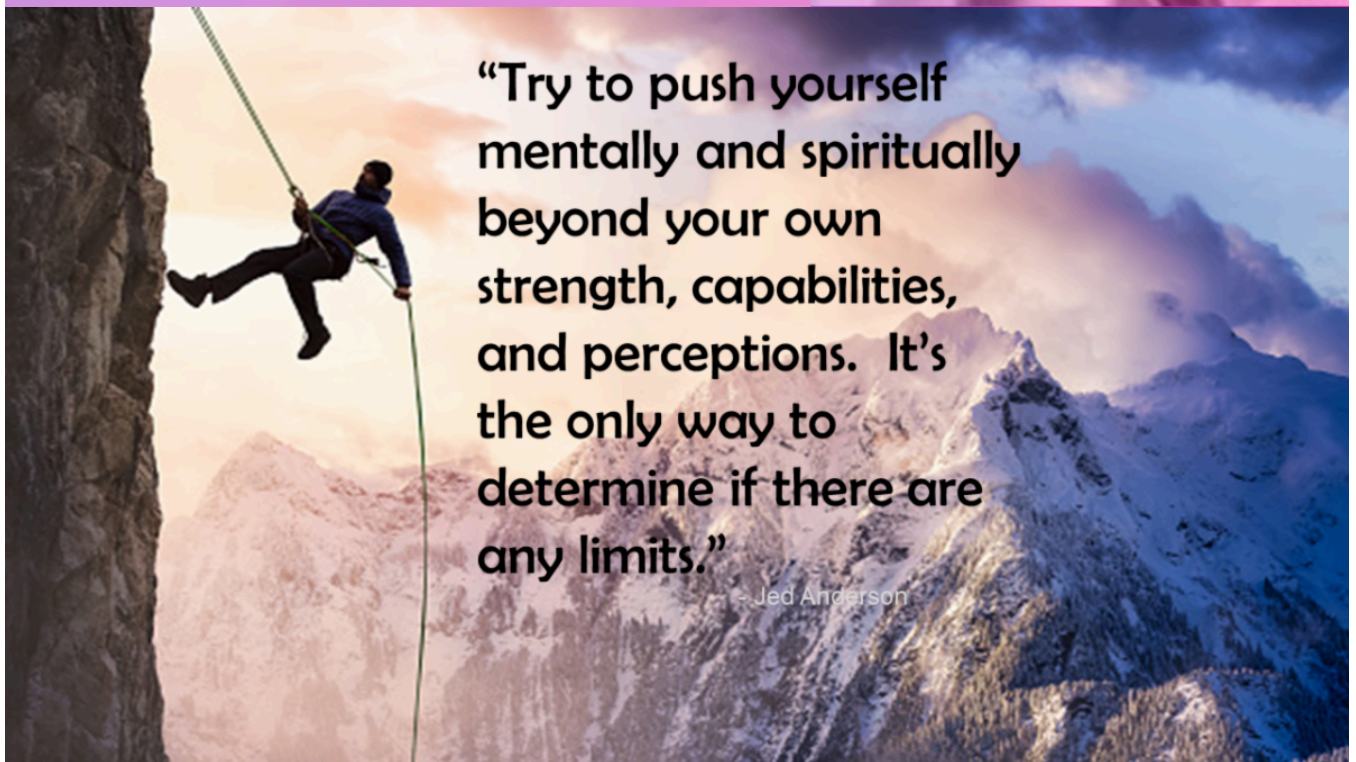

THE HISTORY OF HUMAN PERCEPTION INCREASING

WHAT IS THE UNIVERSE?

The continual iconoclastic evolution in our cosmological understanding ...

- Our Earth is round not flat (this notion of a round earth is contrary to intuition and most of our everyday experience ... half of us on this earth are hanging upside down) - 500 B.C. (Pythagorus) [Eratosthenes calculated circumference in 240 B.C. and of course Columbus didn't sail off the edge of the earth when he tried it almost 2000 years later]
- Our Earth isn't the center of the universe[earth rotates around the sun] - 240 B.C. (Aristarchus) [Calculations by Copernicus in 1532 and astronomical observations by Galileo in 1632]
- Our sun isn't the center of the universe[stars are other suns] - 450 B.C. (Anaxagoras) [Bruno in 1584 and then Angelo Secchi proved through spectroscopy in 1860]
- Our galaxy isn't the center of the universe - 964 (Azophi) [Later Kant, Messier, Shapley, and finally Edwin Hubble ... January 1, 1925 "The day we discovered the universe"]
- Our universe isn't the center of the Universe [or Multiverse]- _____?

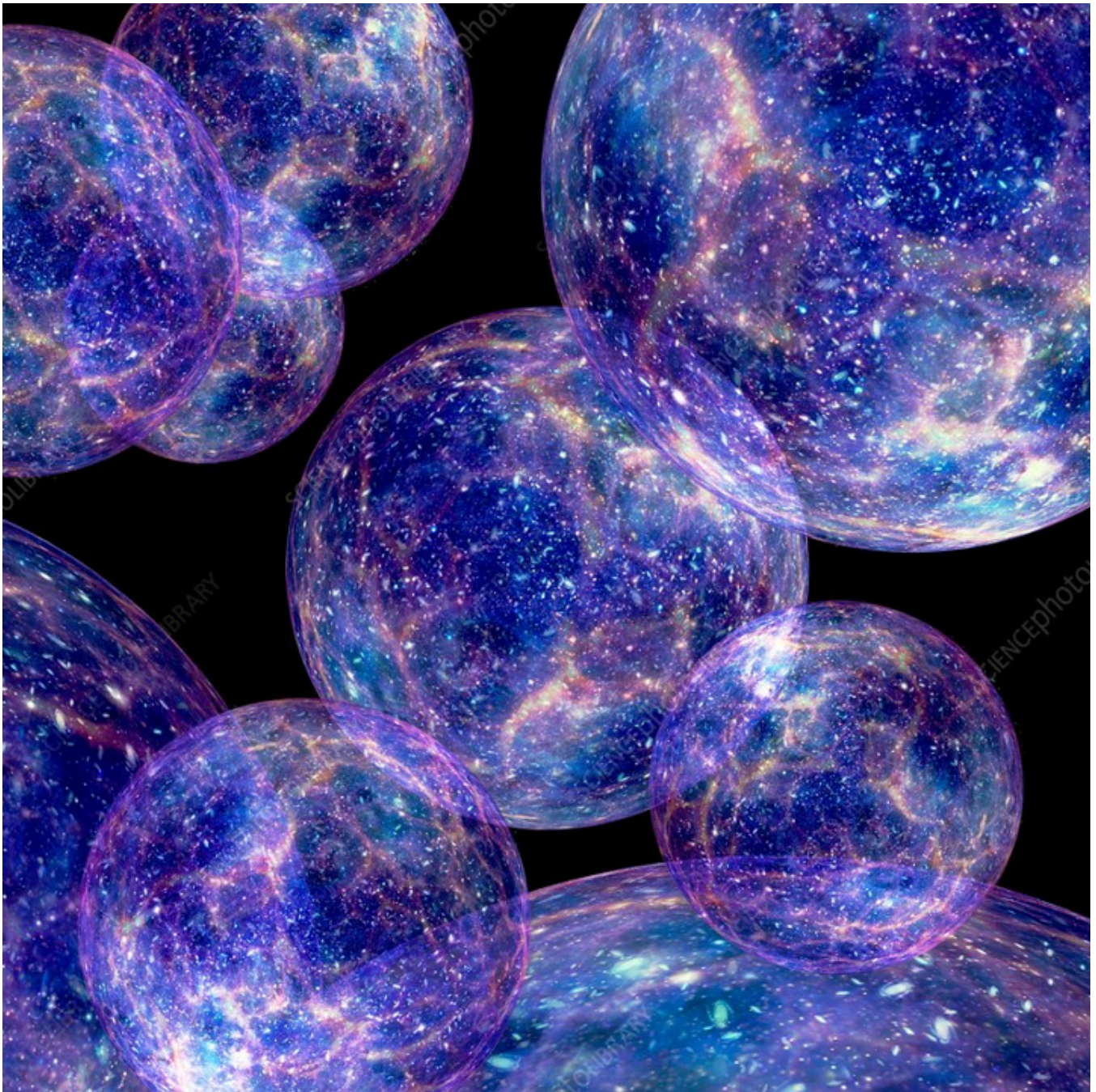

PHYSICS

The continual iconoclastic evolution in our physical understanding ...

- Aristotelian Physics (345 BC)

- **Universe is made of 5 elements** (https://r2o.rs6.net/tn.jsp?f=001p69XCyoK1NDNrAZUv4F6wG9ChyI7WITsJzP_qonHW9yeQoDRr6lPwvrsHdynQsQHfOCV5GQlsMO5DN7hJvR_mGXq6p1bbuIakO-y-Z9pm5E8JWoh7IU5OfQ6w85arVCBvlKjMm4n4bJd-62gBHaPVu7Zl_2VeOTShMxfSmSH7EONJhaPOQ7GoA==&c=&ch=): earth, air, fire, water, and aether.
Objects have natural motions: those of earth and water tend to fall; those of air and fire, to rise.
- Galilean Physics (1592)
- Galileo determines first laws of motion by experimentation
- Develops the concepts of: velocity, force, and inertia
- natural state of motion is uniform motion or rest
- objects fall at same rate regardless of mass
- Keplerian Physics (1609)
- Kepler produces first kinematic description of orbits
- Each object moves in an elliptical orbit
- Newtonian Physics (“Classical Physics” (1687)
- Newton provides dynamical description of universe, using:
 1. acceleration
 2. momentum
 3. conservation laws

[Jed description: Everything on an xyz axis in space-time]

- Quantum Physics (“Modern Physics) (1931)
- Particles are waves and vice-versa
- Probability is all we ever know
- Measurement determines reality

[Jed description: Everything is probabilities]

- _____? (“Post-Modern” Physics)(_____)

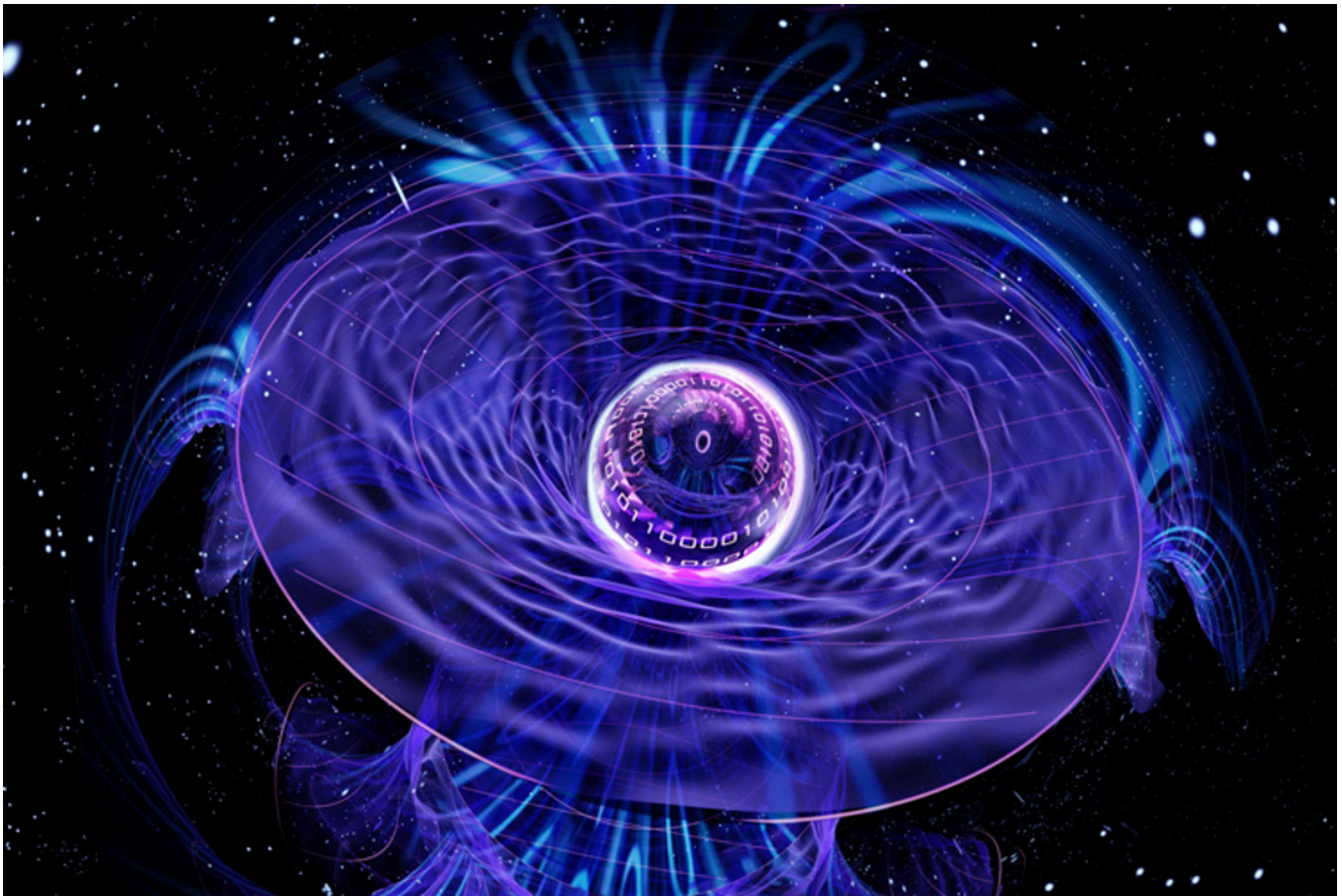

Further Increasing Perception

10 “Perception Exercises” (that I use to help increase perceptions of phenomena beyond what I can see, smell, feel, touch, and taste-----I still have a long way to go! :))

#1- You are warping space and time. Everything with mass warps space and time. Planets have mass. People have mass. You therefore warp space-time just like a planet. (general relativity) This is extremely weird if you think about it. Everything with mass warps space-time.

#2 - While sitting in your chair ... think about the fact that you are also spinning at 1,000 mph around earth ... twirling around the sun at 67,000 mph ... circumnavigating the galaxy at 490,000 mph ... and pirouetting around the universe at 1.3 million mph. You are moving both slow and very, very, very, very, very, very fast! The only reason you don't feel this speed is that everything else around you is moving at the same speed.

#3 - Without doing anything, realize you actually are falling at 9.8 meters per second/per second. Earth is just getting in the way. (General Theory of Relativity ([https://r20.rs6.net/tn.jsp?f=001p69XCyoK1NDNrAZUv4F6wG9ChyI7WITsJzP_qonHW9yeQoDRr6lPwocmKh3IdBuPS5daYKBuED3T8Gr1FFVWpMh1DC5UXtHPp95qxmdy8NJNUaAZGARRRMrhCQPXPOnHRoAJdu84qxQPUvEyakBjhhiDOd5m1tEZFfTyozLW5UUzD9KqHuegE9l2e1Ub9PzithoDf_At5SWUSxLehXMJCMqumELBPyiIrfcvSkMTOrg5hrZRPORQPEcWtRQF-g3j_sHowr5jSWQ=&c=&ch=\)](https://r20.rs6.net/tn.jsp?f=001p69XCyoK1NDNrAZUv4F6wG9ChyI7WITsJzP_qonHW9yeQoDRr6lPwocmKh3IdBuPS5daYKBuED3T8Gr1FFVWpMh1DC5UXtHPp95qxmdy8NJNUaAZGARRRMrhCQPXPOnHRoAJdu84qxQPUvEyakBjhhiDOd5m1tEZFfTyozLW5UUzD9KqHuegE9l2e1Ub9PzithoDf_At5SWUSxLehXMJCMqumELBPyiIrfcvSkMTOrg5hrZRPORQPEcWtRQF-g3j_sHowr5jSWQ=&c=&ch=))))

#4 - Go on a walk. Time is now moving slower for you. (Special Theory of Relativity ([https://r20.rs6.net/tn.jsp?f=001p69XCyoK1NDNrAZUv4F6wG9ChyI7WITsJzP_qonHW9yeQoDRr6lPwocmKh3IdBuPVN3PPU8o8zlnhIunii6ZZ82Le4cxNXDSOLboiLs4qroWmiLn-F_B_dZjjBVhxPuqVQ4prj7u2-Bg-yTxpSZC7gNuQjpldgl5HmnuaC_zj_GKoditOt_sGkQKR74NemMl&c=&ch=\)](https://r20.rs6.net/tn.jsp?f=001p69XCyoK1NDNrAZUv4F6wG9ChyI7WITsJzP_qonHW9yeQoDRr6lPwocmKh3IdBuPVN3PPU8o8zlnhIunii6ZZ82Le4cxNXDSOLboiLs4qroWmiLn-F_B_dZjjBVhxPuqVQ4prj7u2-Bg-yTxpSZC7gNuQjpldgl5HmnuaC_zj_GKoditOt_sGkQKR74NemMl&c=&ch=))))

#5 - Stand on your tip-toes. Time is now going faster for your head. (General Theory of Relativity (

#6 - Look at your desk and realize its mostly space and not matter. (electromagnetic field) (

#7 - Imagine electrons jiggling all around you and remember that some or all of these electrons in and around you are also connected with electrons in distant galaxies and different times (quantum physics/wave-particle duality (

#8 - Look at anything and instead of seeing matter see data.

#9 - Count the number of fundamental forces acting on you. There's only 4! It's that simple! Gravity ... Electromagnetic ... Strong nuclear ... Weak nuclear. Most of what people think as separate forces are actually all part of the same force—the electromagnetic force. The forces underlying nature are much much simpler than most people think, (

sJzP_qonHW9yeQoDRr6lPwsacDIbuVEOP-1ZPfj2mqsPT698kgwwj7G8z_WIwkvHnyWodRIHkO
PJLYC4SEctdar_mSYpY4dmqqAEYqOo9a2ZjGPTXsFeWVHnk8lCDyYYu&c=&ch=) and its
critical we remind ourselves constantly how simple it is.

#10 - [And this is #1 for me and the exercise I struggle with the most] God. The continual presence of Christ. This I think is the biggest sense of reality and perception we are capable of sensing—though I do not have proof and must pursue it through faith. I can't image there being a bigger perception and sense of reality than to be one with God.



More Perceptivity

More Curiosity

More Understanding

More Human Progress

HARBORS

ARE

DANGEROUS

“Entropy wins in harbors and deck chairs.”

Entropy wins in harbors and deck chairs.

Deck chairs are dangerous



If you sit here for any length of
time . . . mentally or physically
. . . **entropy wins.**

Safe places when it comes to entropy ...



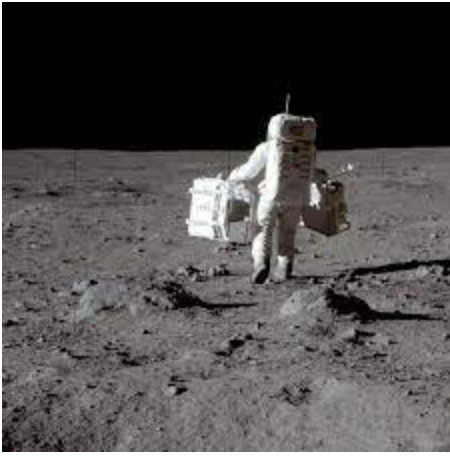

Dangerous places when it comes to entropy ...





FIGHT

ENTROPY

“Everything that comes together falls apart. Everything. The chair I’m sitting on. It was built, and so it will fall apart. I’m gonna fall apart, probably before this chair. And you’re gonna fall apart. The cells and organs and systems that make you you—they came together, grew together, and so must fall apart. The Buddha knew one thing science didn’t prove for millennia after his death: Entropy increases. Things fall apart.”— [J](https://r2o.rs6.net/tn.jsp?f=001p69XCyoK1NDNrAZUv4F6wG9ChyI7WlTsJzP_qonHW9yeQoDRr6lPwi8tTh3PYPwo72ADpfE35z4w6HOCFC5oq_Zdp_ICVRe94otCUJtaesKv3ku-yrhUdbSzEOxdvtxcbnpKpETGVJUoRwoiHhSlx_mI6fB4TvYo&c=&ch=)) [John Green](https://r2o.rs6.net/tn.jsp?f=001p69XCyoK1NDNrAZUv4F6wG9ChyI7WlTsJzP_qonHW9yeQoDRr6lPwi8tTh3PYPwo72ADpfE35z4w6HOCFC5oq_Zdp_ICVRe94otCUJtaesKv3ku-yrhUdbSzEOxdvtxcbnpKpETGVJUoRwoiHhSlx_mI6fB4TvYo&c=&ch=))

“Life, this anti-entropy, ceaselessly reloaded with energy, is a climbing force, toward order amidst chaos, toward light, among the darkness of the indefinite, toward the mystic dream of Love, between the fire which devours itself and the silence of the Cold.”— Albert Claude

“Entropy shakes its angry fist at you for being clever enough to organize the world.”— Brandon Sanderson

“The organism feeds on negative entropy.”

— Erwin Schrodinger

“Living organisms preserve their internal order by taking from their surroundings free energy, in the form of nutrients or sunlight, and returning to their surroundings an equal amount of energy as heat and entropy. A living organism survives by taking

structured energy in the world around it and producing less structured waste energy, in the process using this transformation to repair and possibly grow itself.” - Albert Lehninger

“Technology is the means by which we have decommissioned natural selection and are seizing control. We are no longer to be victims of some blind evolutionary process where sentient beings are massacred by entropy.”

J (https://r20.rs6.net/tn.jsp?f=001p69XCyoK1NDNrAZUv4F6wG9ChyI7WlTsJzP_qonHW9yeQoDRr6lPwi8tTh3PYPwo2ufuRfdYigMMEEcn7oIiNfX3DQDJo6gYlX111o2NQoITbHrnRtosylW6bC03CkXIDt2hhcCWdfWOSxhmIJ4isxBB_-aksYPAibwwBEGO24BOI43bYXKfpwxvOdkRgXhn&c=&ch=)ason Silva

“The total energy of the universe is constant; the total entropy is continually increasing.”— Rudolf Clausius

“J (https://r20.rs6.net/tn.jsp?f=001p69XCyoK1NDNrAZUv4F6wG9ChyI7WlTsJzP_qonHW9yeQoDRr6lPwi8tTh3PYPwoBGRZioJ2gos68lRQOSGoTXge2bz9JdNieGo3PZO3kYswi3UoD9V_w_AsvgUfeFrqQrvOa5wxEcDob-xStTnBkjQfMR4YxPz8oXXM2aHRTxNgVqUos7TmAKcZxNz5Keu4&c=&ch=)ust as entropy is a measure of disorganization, the information carried by a set of messages is a measure of organization. In fact, it is possible to interpret the information carried by a message as essentially the negative of its entropy, and the negative logarithm of its probability. That is, the more probable the message, the less information it gives. Cliches, for example, are less illuminating than great poems.
(https://r20.rs6.net/tn.jsp?f=001p69XCyoK1NDNrAZUv4F6wG9ChyI7WlTsJzP_qonHW9yeQoDRr6lPwi8tTh3PYPwoBGRZioJ2gos68lRQOSGoTXge2bz9JdNieGo3PZO3kYswi3UoD9V_w_AsvgU

feFrqQrvOa5wxEcDob-xStTnBkjqfMR4YxPz8oXXM2aHRTxNgVqUos7TmAKcZxNz5Keu4&c=&ch
=) -Norbert Wiener ([https://r2o.rs6.net/tn.jsp?f=001p69XCyoK1NDNrAZUv4F6wG9ChyI7Wl
TsJzP_qonHW9yeQoDRr6lPwi8tTh3PYPwoMLoWNDVOQH_mUHGcHPuXK7oqe6dWCs-GSku5
vSAETC99hLiNg_1WEKo_NxGBQZf86yG-Hadc41jybrXjk8Skx9UiQmmomi8NCCC510LFt1ViUn5
dGSmpnA==&c=&ch=](https://r2o.rs6.net/tn.jsp?f=001p69XCyoK1NDNrAZUv4F6wG9ChyI7Wl
TsJzP_qonHW9yeQoDRr6lPwi8tTh3PYPwoMLoWNDVOQH_mUHGcHPuXK7oqe6dWCs-GSku5
vSAETC99hLiNg_1WEKo_NxGBQZf86yG-Hadc41jybrXjk8Skx9UiQmmomi8NCCC510LFt1ViUn5
dGSmpnA==&c=&ch=))

“If we knew exactly what animal life was like before the fall into sin and knew what nature was like before the law of entropy invaded it, we would already be living in heaven.”

— Walter Lang

“I think you should always be aware that entropy is not on your side.” - Elon Musk

“It was not easy for a person brought up in the ways of classical thermodynamics to come around to the idea that gain of entropy eventually is nothing more nor less than loss of information.”— Gilbert N. Lewis

“It sometimes seems as if curbing entropy is our quixotic purpose in this universe.”— James Gleick

“The powerful notion of entropy, which comes from a very special branch of physics ... is certainly useful in the study of communication and quite helpful when applied in the theory of language.”— J. Robert Oppenheimer

“Only entropy comes easy.”— Lewis Mumford

“Information is synonymous with Entropy. While entropy has universal applications, it is merely a measure of uncertainty in discrete packages called ‘bits’, as coined by Claude Shannon. For instance, if you increase your own entropy, you

increase uncertainty of something, but if you decrease your own entropy, you reduce uncertainty while increasing your knowledge of something instead.”

“Information is entropy and technology is a method which allows us to reduce entropy and make decisions; often at a prodigious rate in comparison to what we could accomplish without it.”

“To most people, the word “information” suggests meaning and reality. To the communication engineer, it is the problem of getting a wave form from one point to another or, more simply, a series of letters, or, simpler still, a series of zeros and ones.” – Claude Shannon

“Entropy only moves in one direction—toward equilibrium—unless acted upon by a force outside the system, and even then, outside forces like biological systems only temporarily succeed in reversing the entropy process and ultimately relent (via death). Any plant or animal is a complex energy system that survives by offsetting the entropic process and gathering available, ordered energy from the environment then emitting waste stripped of nutrients. But the throughput of energy in the living system eventually degrades its physical structure, causing the organism to break down and die (hopefully having completed its ultimate goal of reproduction). The body of energy, no longer living, will decompose and dissipate into the surrounding environment—and thermodynamic equilibrium.”

“According to Shannon, the entropy value of a piece of information provides an absolute limit on the shortest possible average length of a message, or how much it can be compressed, without losing information as it is transmitted. Semiconductors, flashlights, and tapping on a pan in Morse Code requires human energy, and our communications will always strive for the most efficient means of transmission.”

“In energy, we try to minimize entropy by limiting how much we consume and how efficiently we consume it. Our goal is to find ordered sources of energy and resist the influence of entropy on our bodies. In communications, we minimize entropy by finding information and reducing uncertainty. In a way, by reducing disorder via communication, we can halt the entropic process of energy; a hunter-gatherer can use language to communicate with another to warn about being eaten by a lion, both reducing the uncertainty of 1. where the lion is (information entropy) and 2. the process of being eaten by a lion (energy entropy). This act of communicating reduces the probability space of all possible events and allows us to act more efficiently and effectively. Understanding the nature of how this powerful law operates in the digital and physical realms is key to understanding the connections between thermodynamics and the information age.”

“Death is not necessarily what gives meaning to life LIFE gives meaning to life, and what we do with life, which is to create knowledge like music, art, science To this end, I believe intelligent life might be evolution’s secret weapon: the ultimate hack that might help us transcend entropy.” — [“I think we defy entropy and impermanence with our films and our poems. We hold onto each other a little harder and say, ‘I will not let go. I do not accept the ephemeral nature of this moment. I’m going to extend it...forever. Or at least I’m going to try.’-](https://r20.rs6.net/tn.jsp?f=001p69XCyoK1NDNrAZUv4F6wG9ChyI7WITsJzP_qonHW9yeQoDRr6lPwi8tTh3PYPwoadjIzul33DWz3E8SE5iOOXSzVH7iXOuPd1znl9yUpjPnnOu9dvI5jFh-D4UXCyCQ91rR647-S4nDyWSdYeMcxH9rJtVPoU_9rYc7LxcuyiE=&c=&ch=)ason Silva</p></div><div data-bbox=)

“People will try to tell you that all the great opportunities have been snapped up. In reality, the world changes every second, blowing new opportunities in all directions, including yours.”

— Ken Hakuta

“Courage is fear that has said its prayers.”

— Anne Lamott

“If we don’t change, we don’t grow. If we don’t grow, we aren’t really living.”

— Anatole France

“To improve is to change, so to be perfect is to have changed often.”

— Winston Churchill

“Progress is impossible without change, and those who cannot change their minds cannot change anything.”

— George Bernard Shaw

“To exist is to change, to change is to mature, to mature is to go on creating oneself endlessly.”

— Henri Bergson

“For nothing is fixed, forever and forever and forever, it is not fixed; the earth is always shifting, the light is always changing, the sea does not cease to grind down rock.”

— James Baldwin

“Change is the law of life. And those who look only to the past or present are certain to miss the future.”

— John F. Kennedy

“We are like eggs at present. And you cannot go on indefinitely being just an ordinary, decent egg. We must be hatched or go bad.”

— C.S. Lewis



“If and when we learn how to combine bits in fantastically large numbers to obtain what we call existence, we will know better what we mean both by bit and by existence.”

- John Archibald Wheeler

(physicist who came up with the term "black hole")

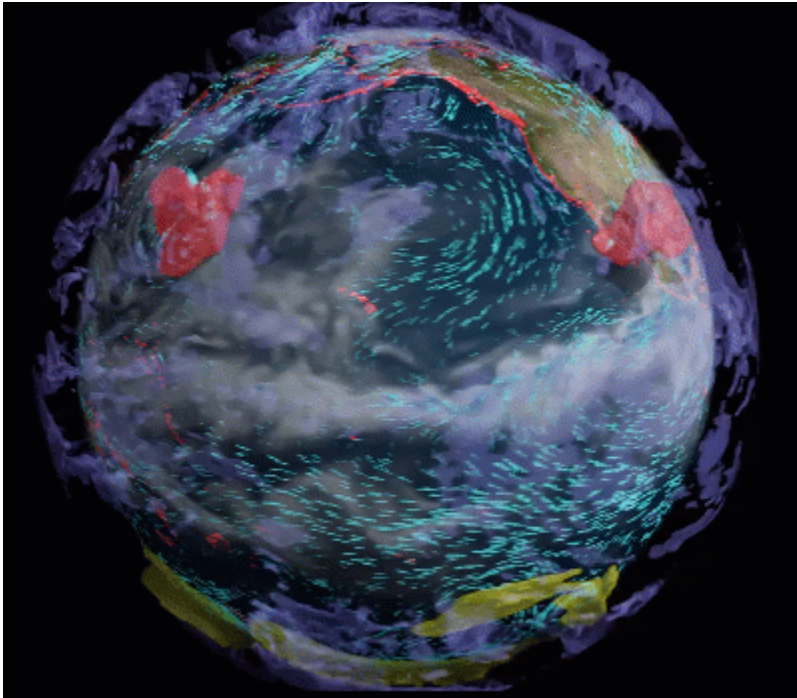

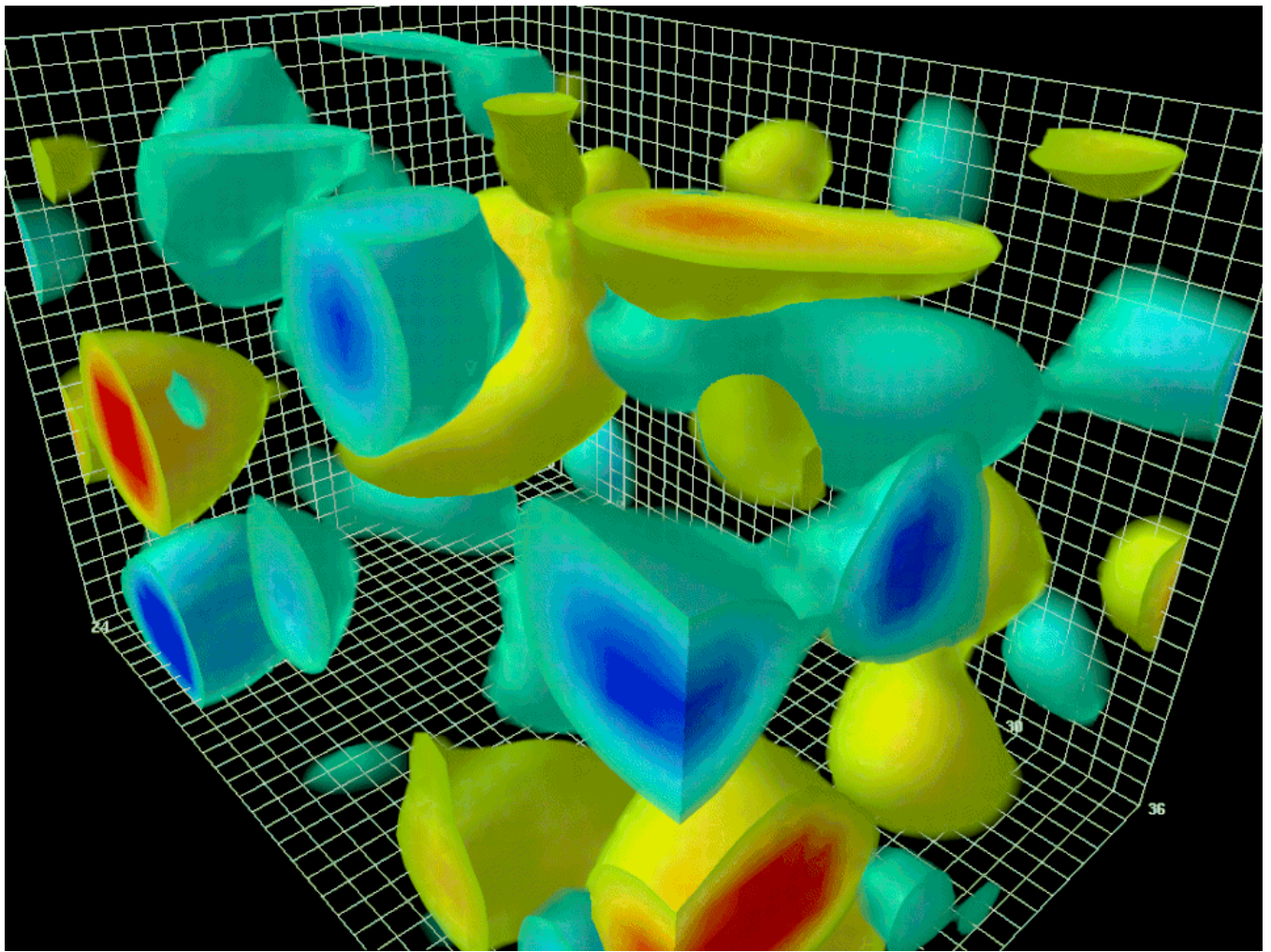



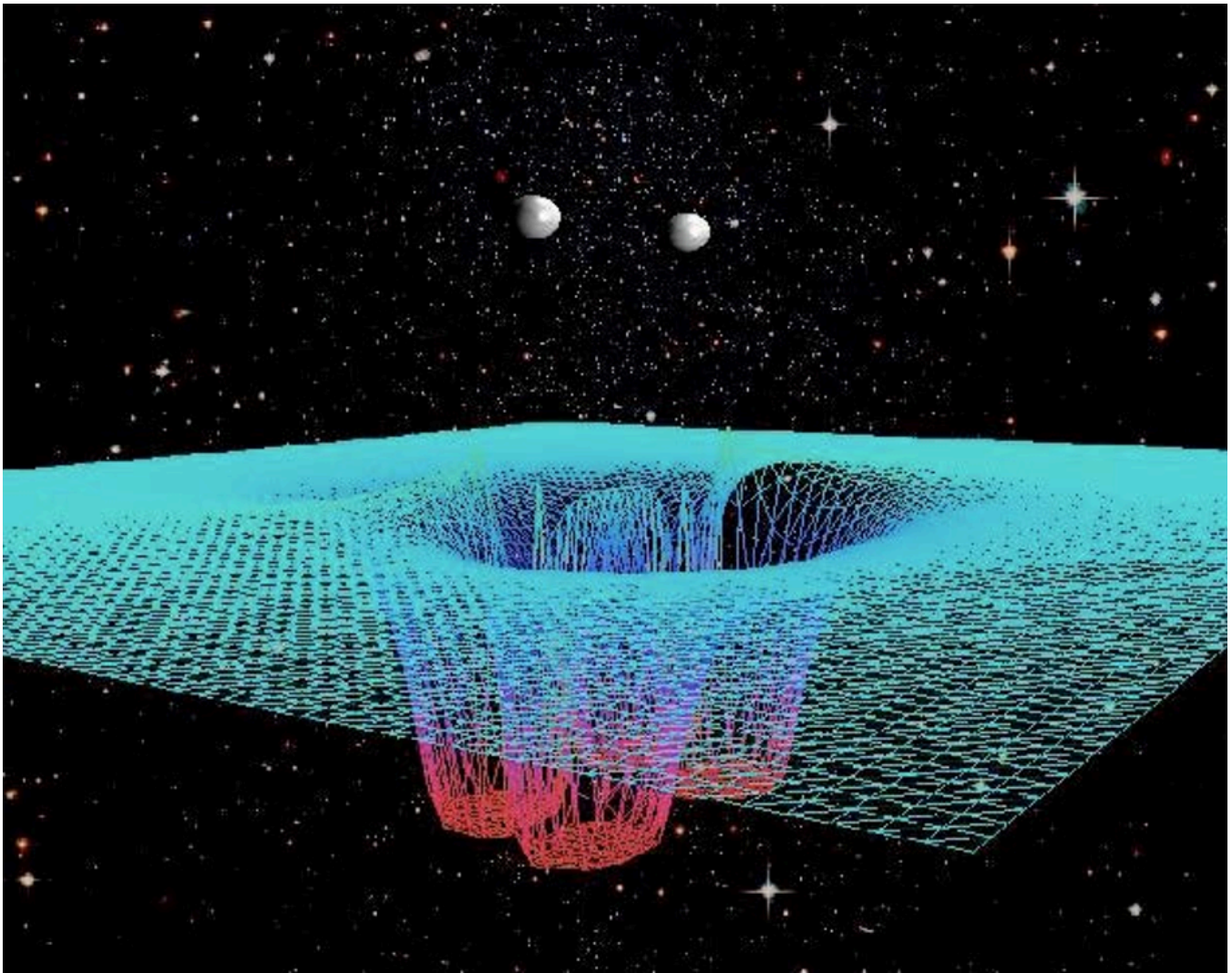

“Matter (Heisenberg/Einstein/Bohr/Schroedinger), mathematics (Godel’s incompleteness theorem), and computation (Turing/Shannon/Kolmogorov-Chaitlin complexity-halting problem) all seem to similarly break down at the same point. The fact that they all break down, where they break down, and this relationship does not appear to be coincidental. In fact, they all seem to be saying the same thing (but in different ways) and pointing in the same direction.”

- Jed Anderson

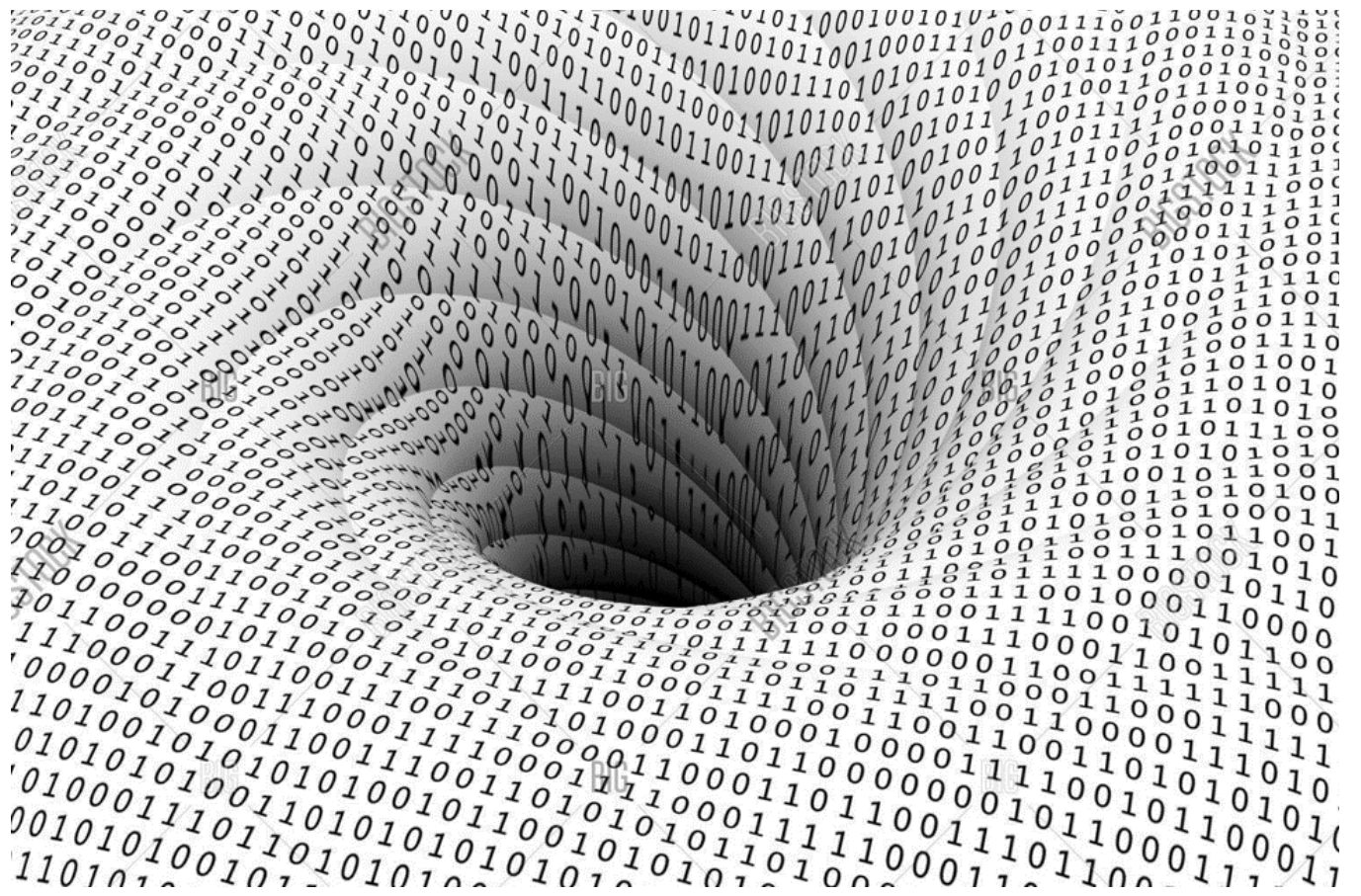

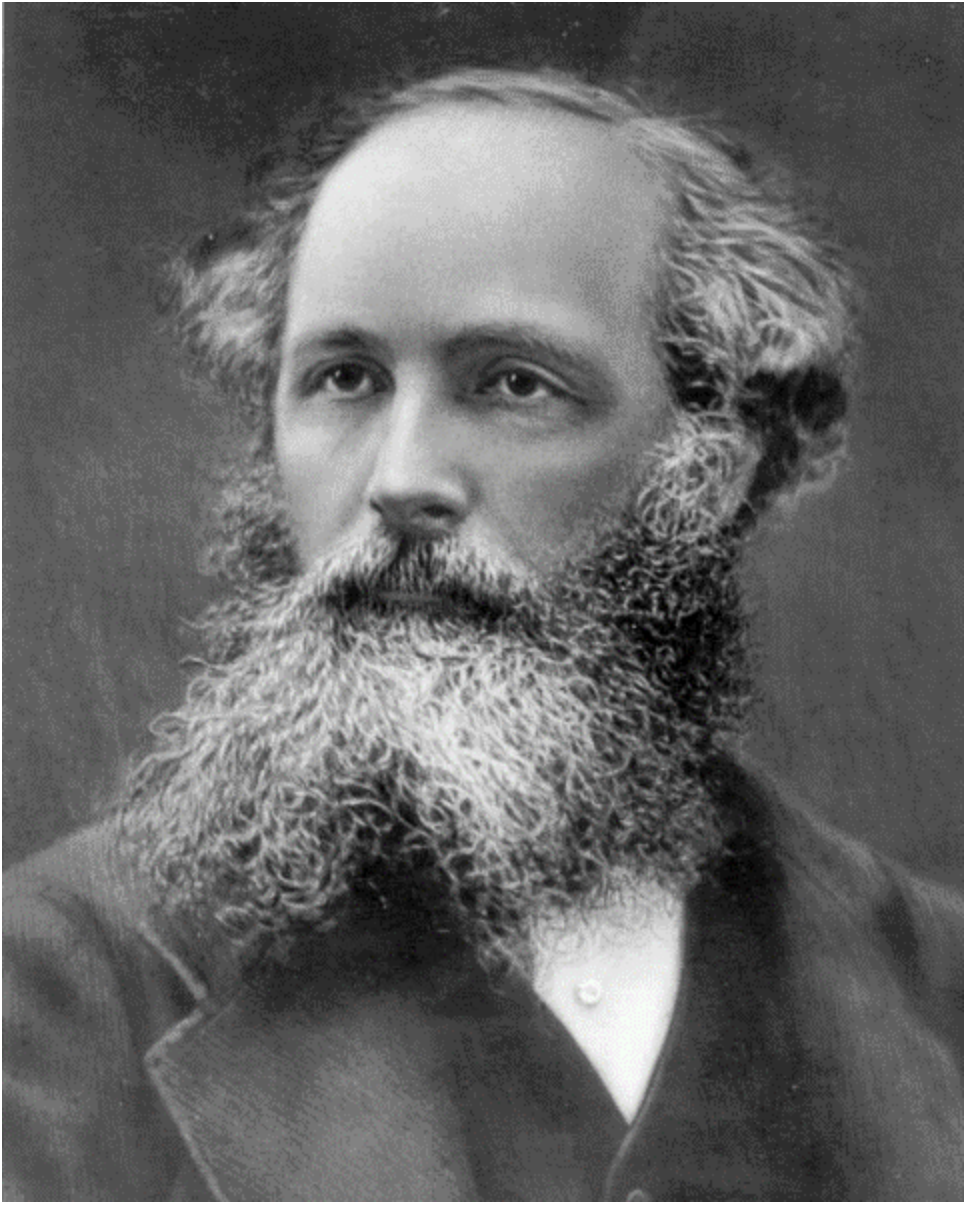

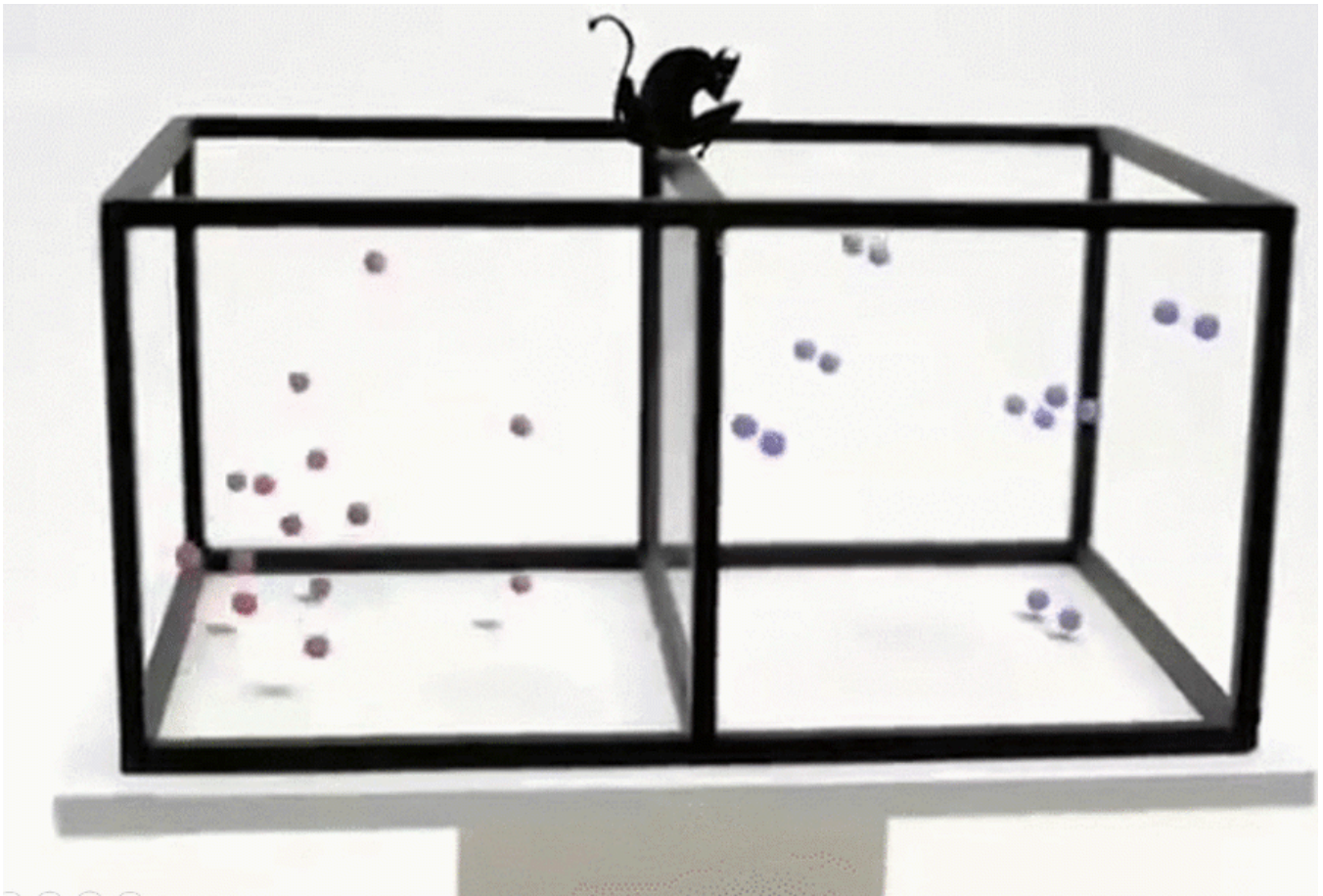

”---“Simpler to control pollution as information than as matter.”

- Jed Anderson, EnviroAI



“It from bit.” - John Wheeler

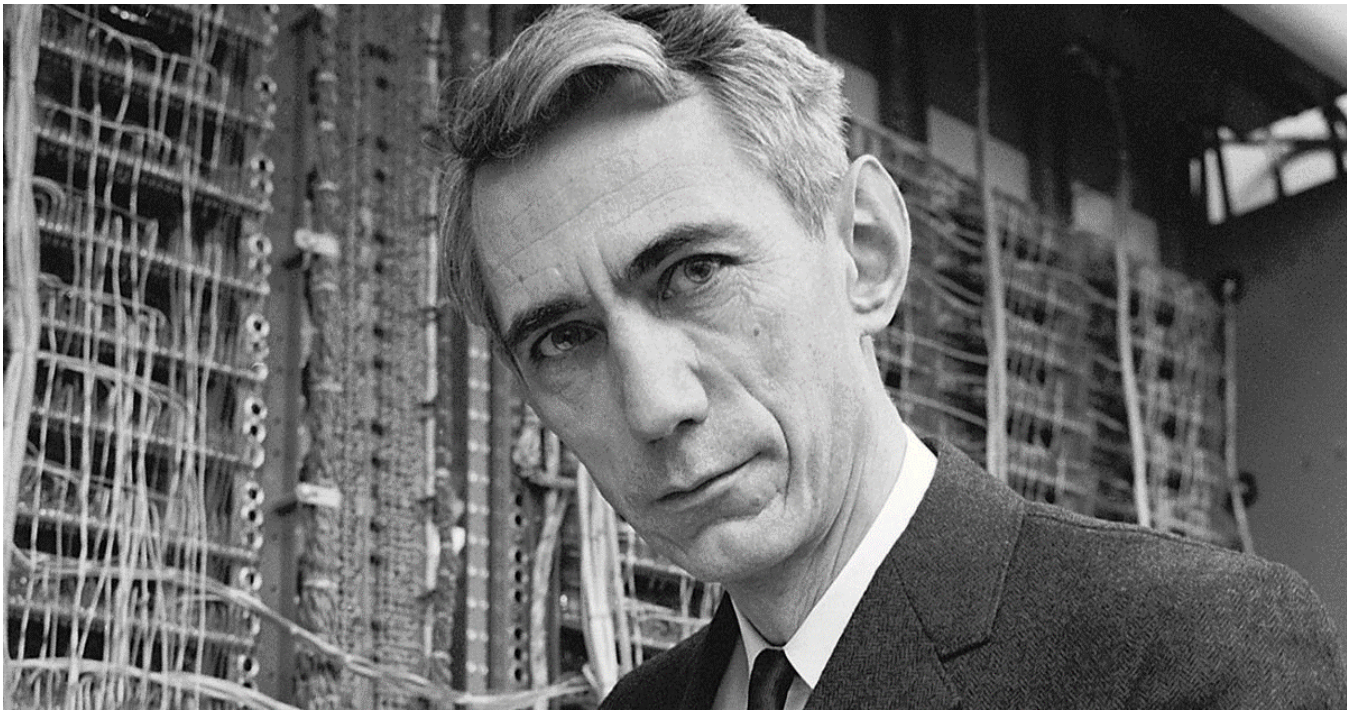

“Information: the negative reciprocal of probability.”- Claude Shannon

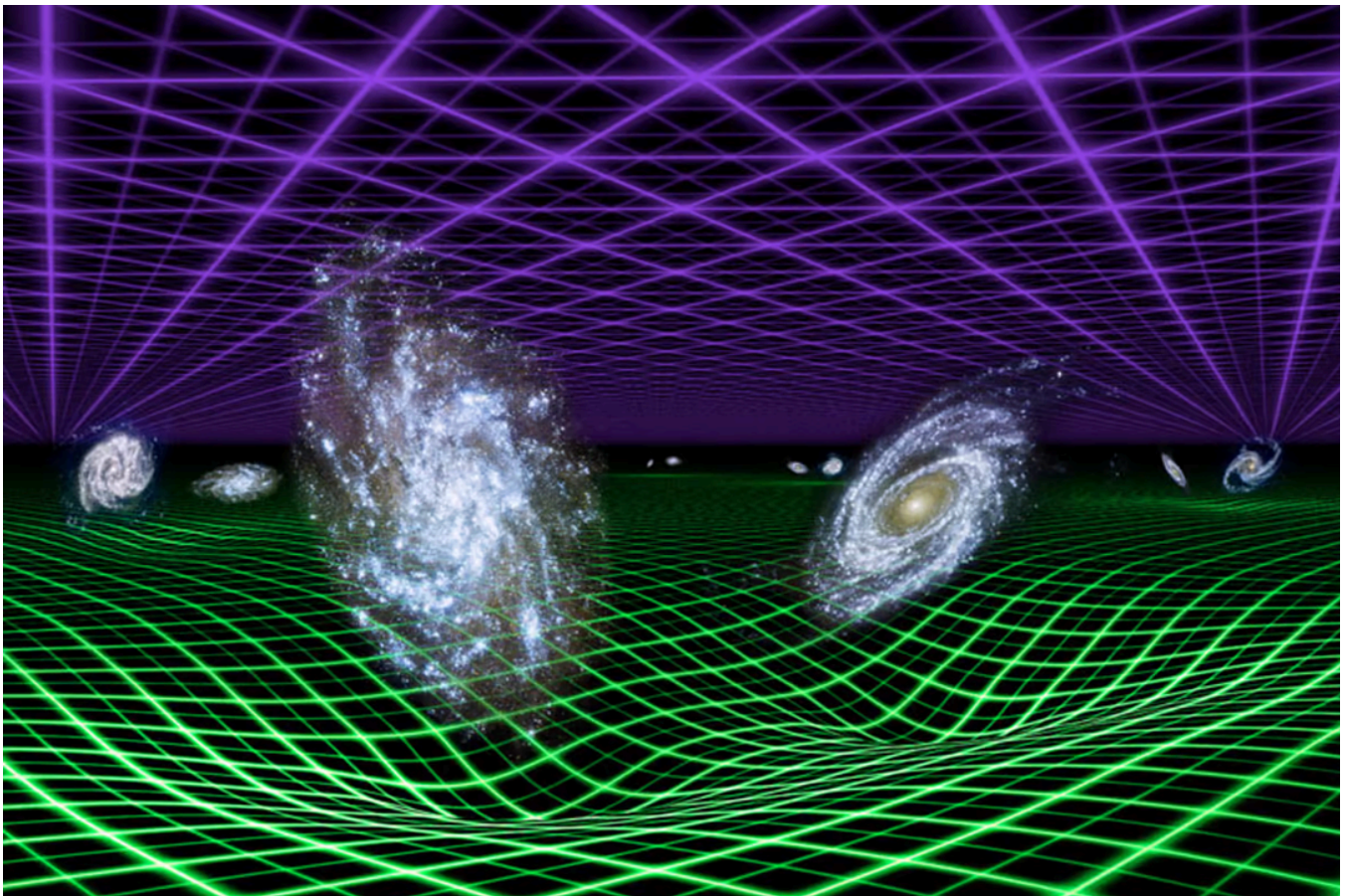

$$H = - \sum_{i=1}^N p_i \log(p_i)$$

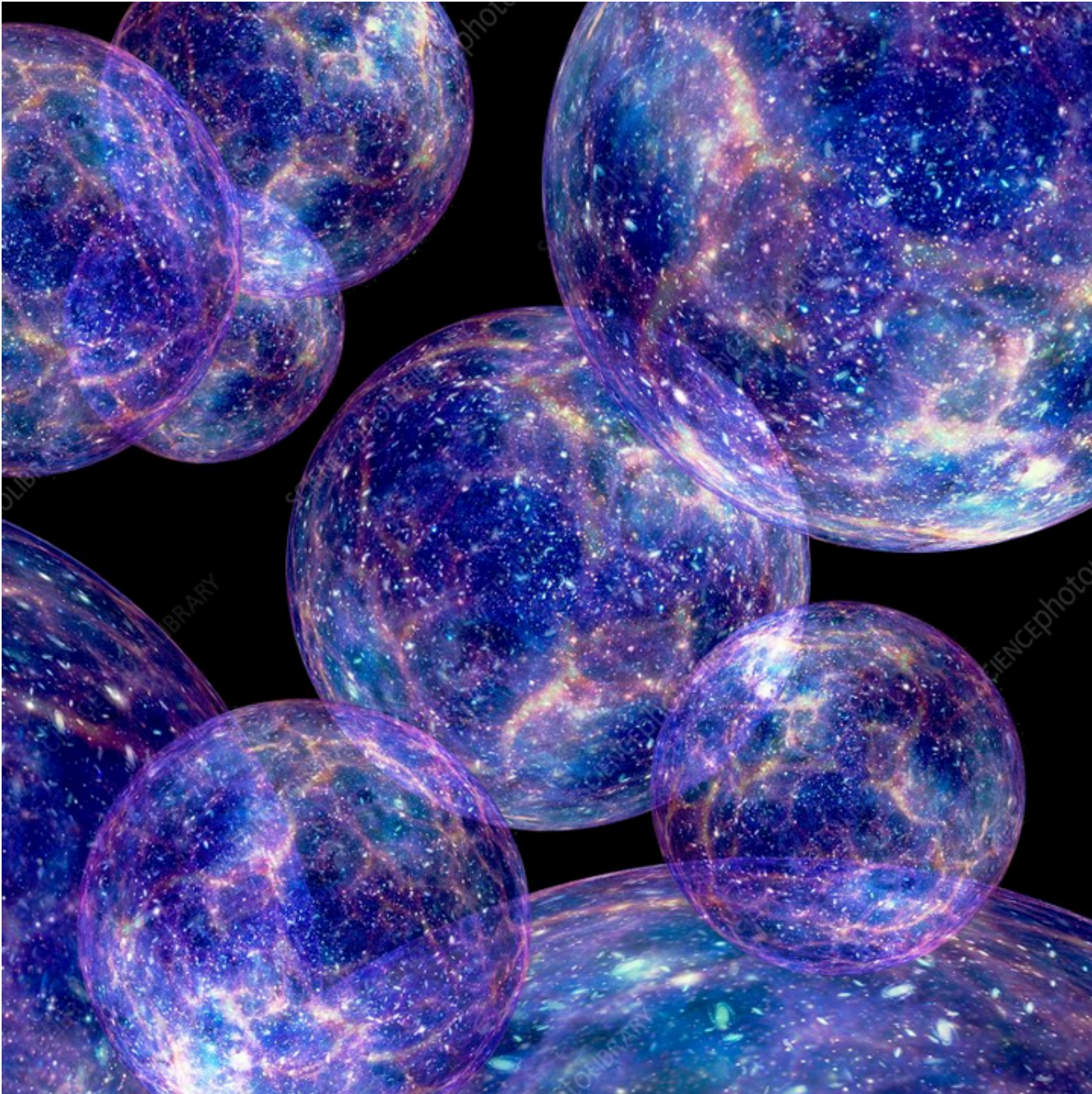



“The world is focused on protecting the environment fundamentally as a physical structure. We’re the first company considering it might be more ‘information-based’ at its foundation than what humans have been historically and traditionally thinking —and creating a system to help try to protect it as such. Simpler. Faster. Less energy involved in utilizing an information-based protection system.”

- Jed Anderson, CEO, EnviroAI

Is the environment more fundamentally matter or information?

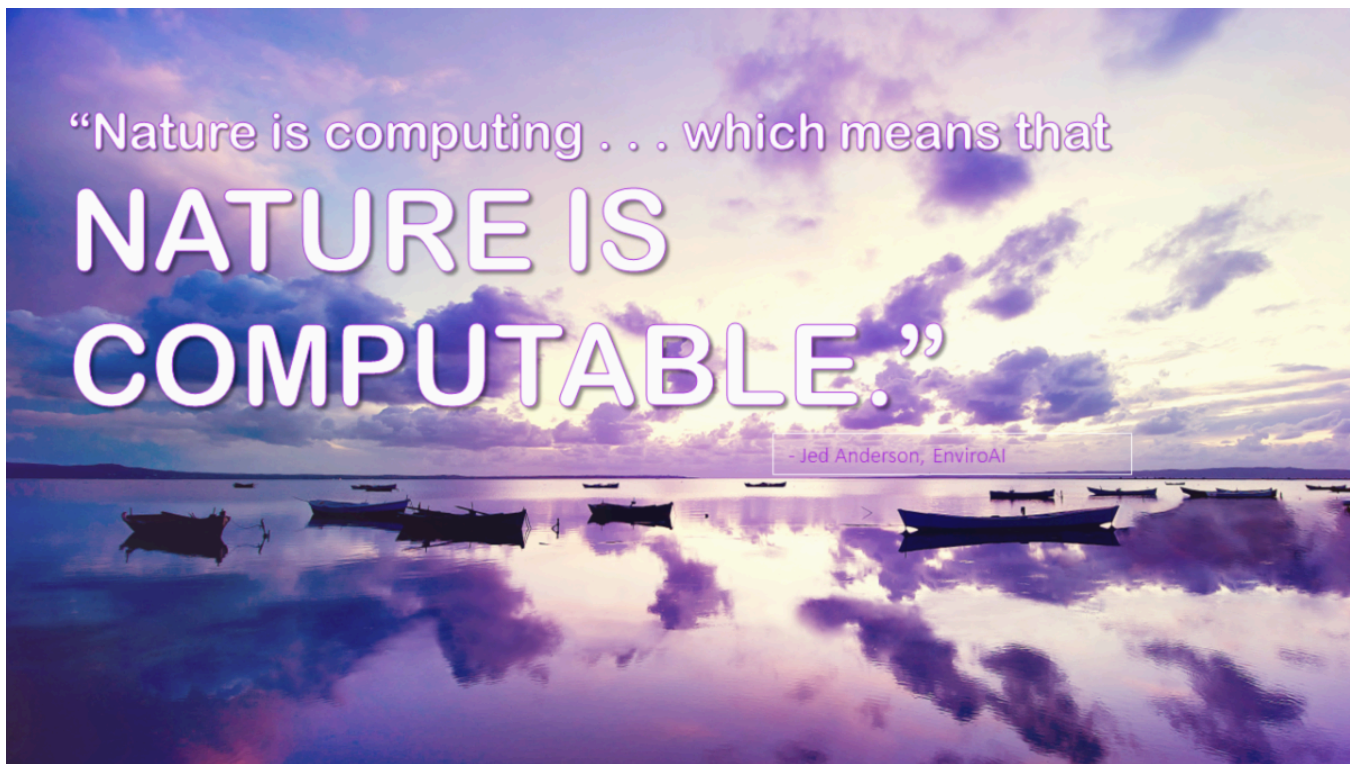

Nick Bostrom at Oxford, David Deutsch at Oxford, Elon Musk, Neils deGrasse Tyson, Seth Lloyd at MIT, these Microsoft scientists that recently wrote this paper entitled “The Autodidactic Universe ([Is the universe acting like an autodidactic computer?](https://r2o.rs6.net/tn.jsp?f=001p69XCyoK1NDNrAZUv4F6wG9ChyI7WlTsJzP_qonHW9yeQoDRr6lPwtudewaw7oIcT6AOao1zfnofVafzk-llA-zc5ovbqnC2ZUXAIc57_z8jQMoIocMWz-VlNSmpy55C4lv_HiDT_nBWHQvUnB9PNVPkXMeZT_df&c=&ch=)”, and others think the odds are that we’re living in a simulation or a computer. I WILL NOT TOUCH THIS HYPOTHESIS. I DON’T NEED TO. I frankly don’t care what we call it. The odds are 100% that even if this is not a computer ... it will keep acting like a computer because that’s what its doing. It’s computing.</u></p></div><div data-bbox=)



---“If it looks like a duck, swims like a duck, and quacks like a duck ... then its ... not necessarily a duck ... but the odds have gone up considerably now that it also likes crackers.” - Jed Anderson, EnviroAI



Even if the Universe is not a computer, or simulation ... the mathematical, computational, and informational underpinnings make you scratch your head sometimes and wonder why this thing is acting like a duck.

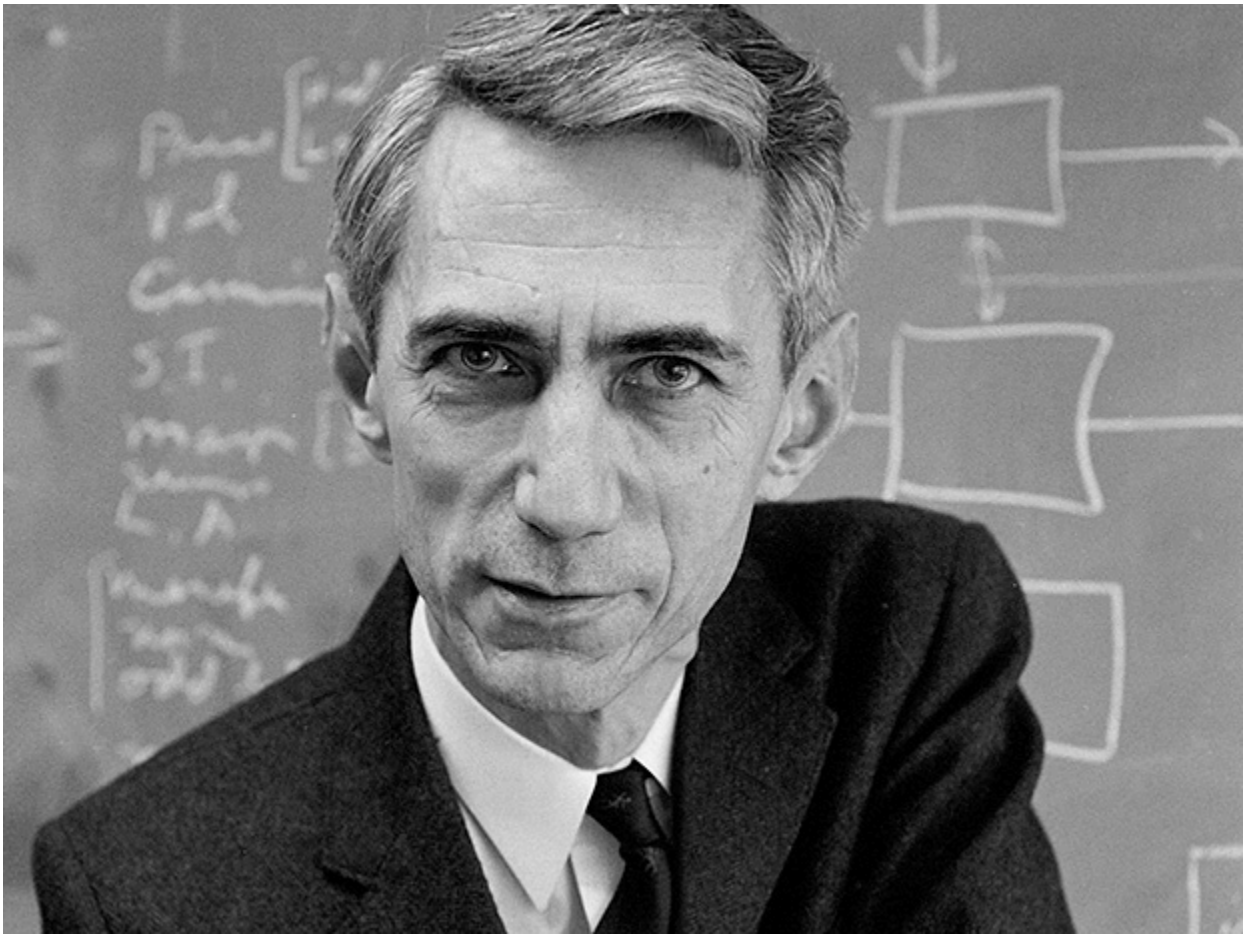

Shannon's entropy equation

$$H(X) = - \sum_{i=0}^{N-1} p_i \log_2 p_i$$

Mathematics for Life

The image shows a network of interconnected nodes and lines in various colors (pink, purple, blue, green) on a light background. A blue rectangular box highlights the text "Shannon's entropy equation". Below it, a larger purple rectangular box contains the mathematical formula for Shannon's entropy equation. At the bottom of the network, the text "Mathematics for Life" is visible.

“I can go a couple hours ... sometimes a couple days ... and then I’m back thinking about Claude Shannon again.”

- Jed Anderson, EnviroAI

Protecting the Environment Using Information Theory

I’m not sure why **Claude Shannon** (https://r2o.rs6.net/tn.jsp?f=001p69XCyoK1NDNrAZUv4F6wG9ChyI7WlTsJzP_qonHW9yeQoDRr6lPwiKoZYtZd5GFNoGpvTQInuQLNpFTKouqWVXoXCJHsCQvXNtkTw2XdpFHjY5HhlCYwzMocb6QY1U4xOPNprL12MMGKt5GQlBtA==&c=&ch=) is not known as well as Einstein. The implications of **his work** (https://r2o.rs6.net/tn.jsp?f=001p69XCyoK1NDNrAZUv4F6wG9ChyI7WlTsJzP_qonHW9yeQoDRr6lPwiKoZYtZd5GFQKQfkOBOevkD5NUGHQMbaT9inoeZlmFwk9LG13zI5YFcwXm4VQDEcvFrI_vqKQYqlgLgWAfbBKlA9t5uG9O7XBstr_nwpkdlUYkl9X96PioN6wR96jHow==&c=&ch=) might already be larger (the creator of the digital age). And the imaginative cerebral catapult he did I think was no smaller than arriving at relativity. I think the reason might be there has

historically been a prejudice in favor of matter over information in terms of trying to better understand the universe, certainly in the physics community, and also likely in the public at large. That's changing. I also think that even Claude was not fully aware of the "can of worms" he opened ... although I think he had a pretty darn good idea—especially tying entropy to information (https://r2o.rs6.net/tn.jsp?f=001p69XCyOK1NDNrAZUv4F6wG9ChyI7WlTsJzP_qonHW9yeQoDRr6lPwiKoZYtZd5GFhLfmK9GhMoGTRmlfGb5ZwVB4uFR4CpNNXSmCsqsbbNHQcmgqeaFy97B2Yx5mGEC3yHeJHr_a7QIrmnFlSFVWP-rYmAIGUTa9_DrCkns4OCJGg4sC2TtV-g==&c=&ch=). Wow! What a catapult that was! Cerebral gymnastics on the high-bar! I'm looking up at him from down here in the audience just aghast. It's like going to an intellectual Cirque du Soleil. You think, the guy's a nut. He's crazy. There's no way he's going to pull this off. And then he does it. And then you say to yourself, I can't believe the idiot, I mean genius, actually did it. How on earth did he do that. How did he get here from over there. And then you look at his underlying reasoning and you say, "oh, that's how he did it." "That's how he made that jump." From the ground it looked impossible, but from his vantage and all the work and creativity he had poured into it, it was the next logical jump. Another day at the office. Extraordinary. Most of the implications of Claude Shannon's work are only now coming to fruition (ex. Quantum Information Theory).

The Environment as an Information System

Error correction?

Data compression?

What about some Claude Shannon-level outside the box thinking on environmental problems? Not only look at physical solutions to environmental problems (physical ways to reduce "the noise"), but information systems solutions. It's never been thought of or attempted before, but if the environment is information or can be

expressed as information, then manage it like its information. Introduce error correction, compression, encoders/decoders, etc. Shannon principles. Might be simpler and easier than physical solutions ... and as Professor MacKay says ... sure would be “Exciting!”:

Professor MacKay (lecture snippet (

“Imagine that we’re trying to achieve this goal. That we’re trying to make a reliable communication system. What sort of approaches could we go for? What solutions are there?

Well, we can perhaps categorize solutions to this goal in two ways. Either there are physical solutions where you throw away the lousy disk drive and replace it by a better one that’s more expensive ... or maybe you take your copper wires and you put better insulation on them ... or you use a colder magnetic film—add cooling so you change the physics to reduce the noise.

So there’s physical solutions.

Alternatively, we could talk about system solutions.

And the idea of a system solution is we accept the lousy channel as it is and we add encoding and decoding systems around that channel to turn it into a reliable channel. So this is a much more exciting approach than the physical approach. Physics is exciting too, but the system approach accepts the unreliable system as it is and transforms it into a reliable system. And that’s what information theory is about.” – Professor David MacKay, Cambridge University

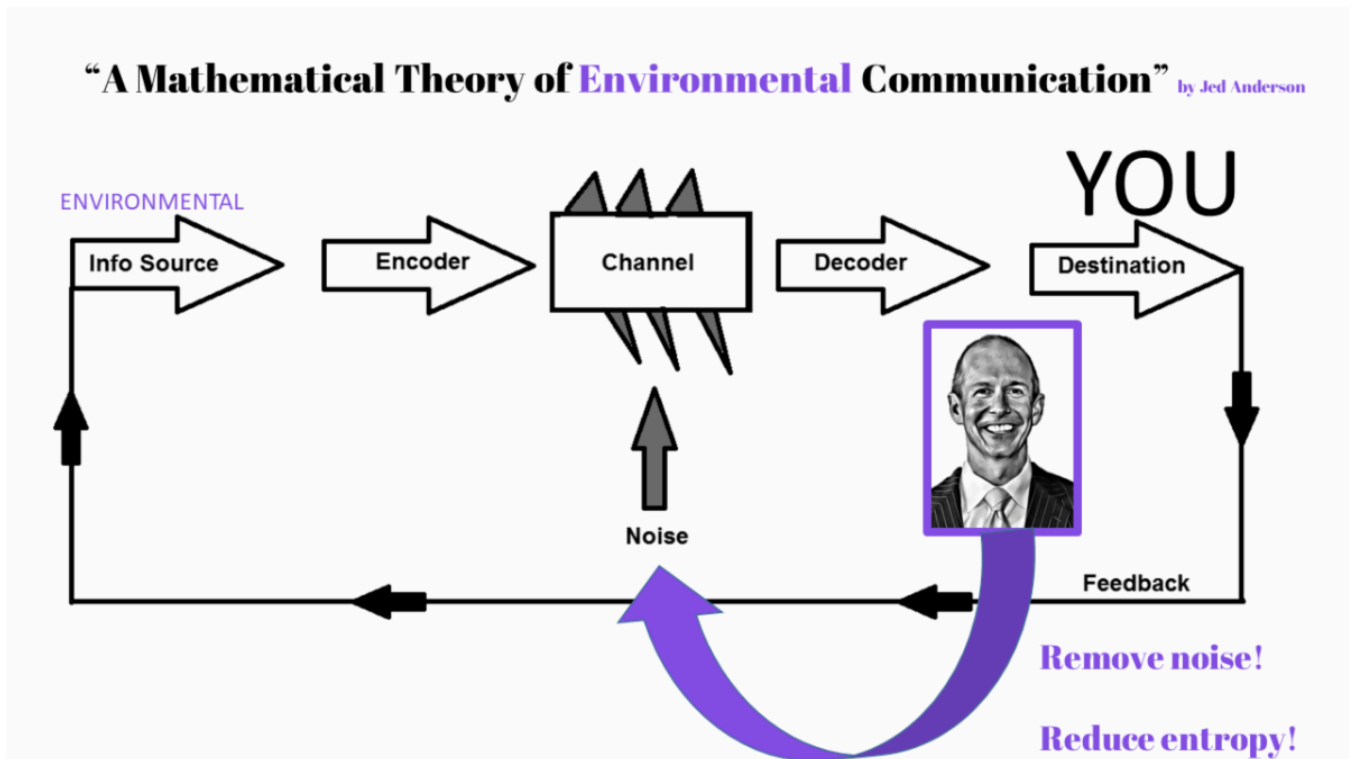
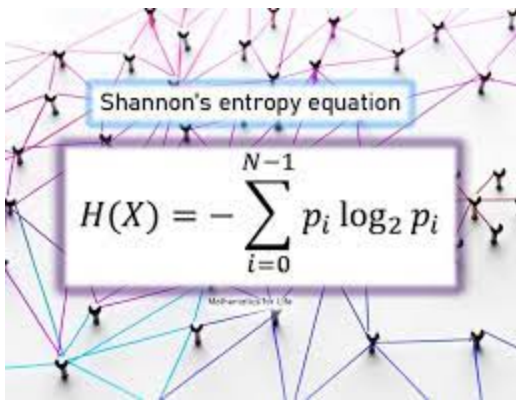

Remember ... and this is critical... I'm not talking about changing the “environmental signal”. I'm talking about reducing the noise ... reducing the complexity. It will be like talking to your friend on the cell phone. It's still your friend's voice on the cell phone. It's still the same content. In fact, its better content and a higher quality. Does anyone think that the person they speak to on an analog phone is different than the person they speak to on a digital phone? I don't think so. No one is that naive.

It's a fascinating world ahead of us.



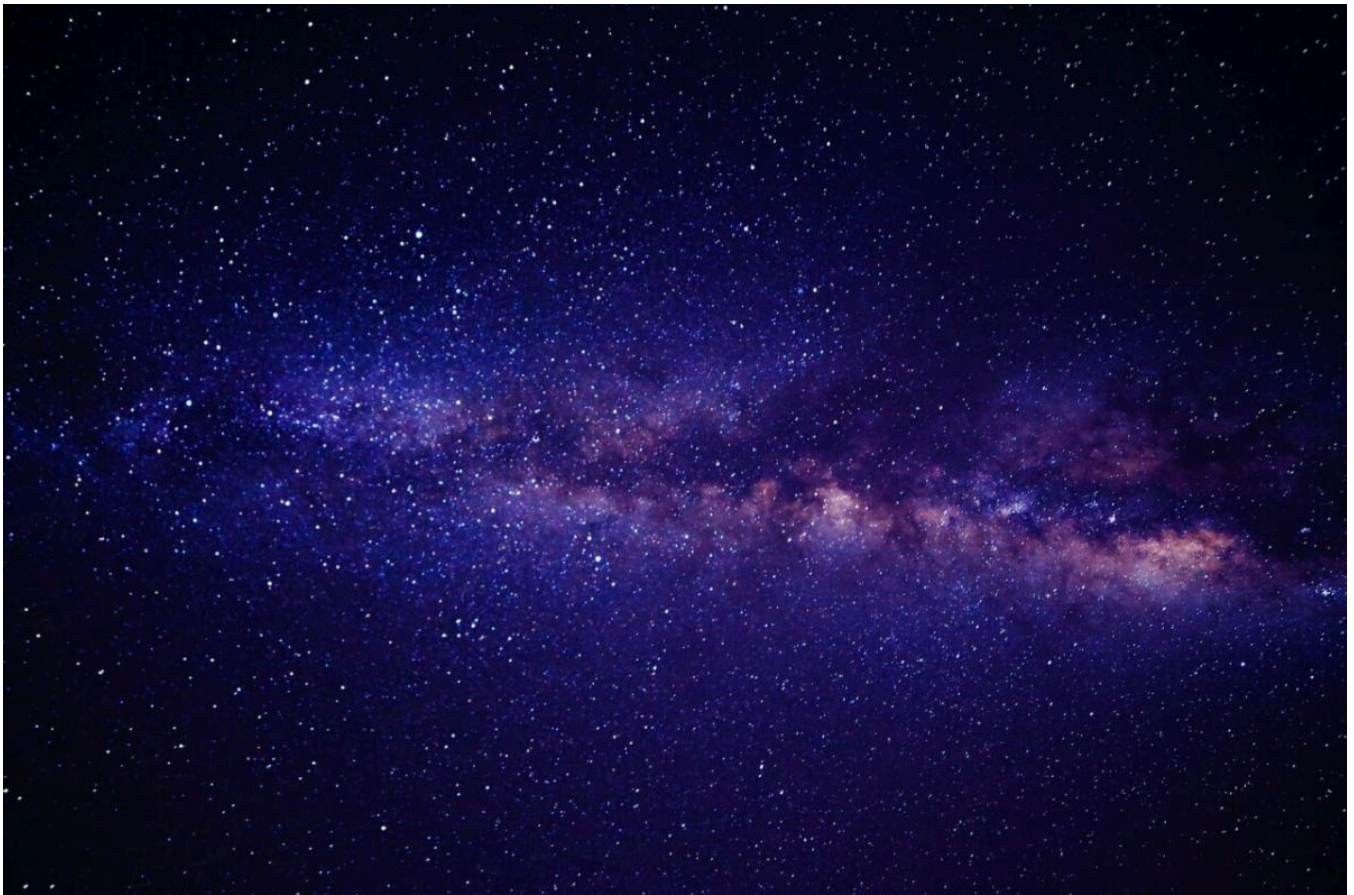

... “To think that our big bang was the only bang would seem at this point to me to be a bit narrow-minded, anthropocentric, and in contradiction to the continual iconoclastic evolution in our cosmological understanding.”

- Jed Anderson, EnviroAI

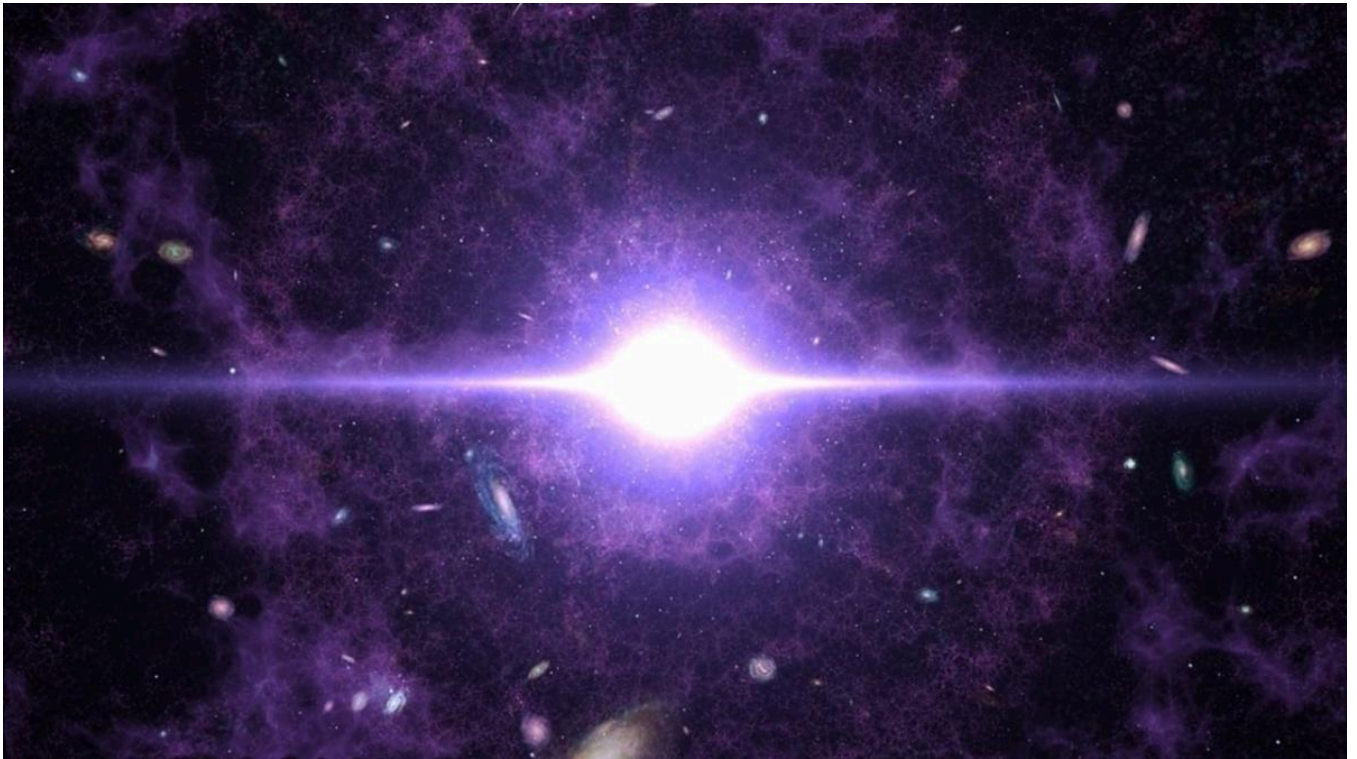



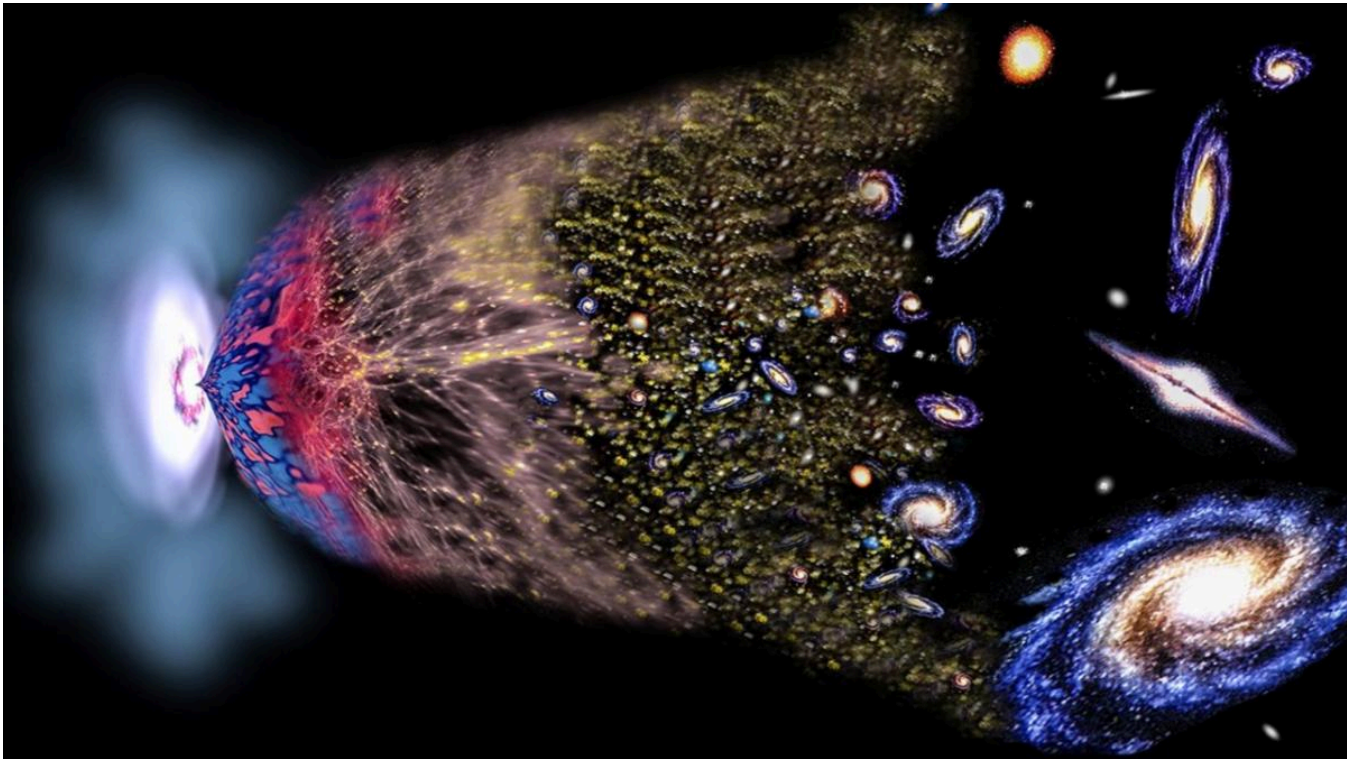
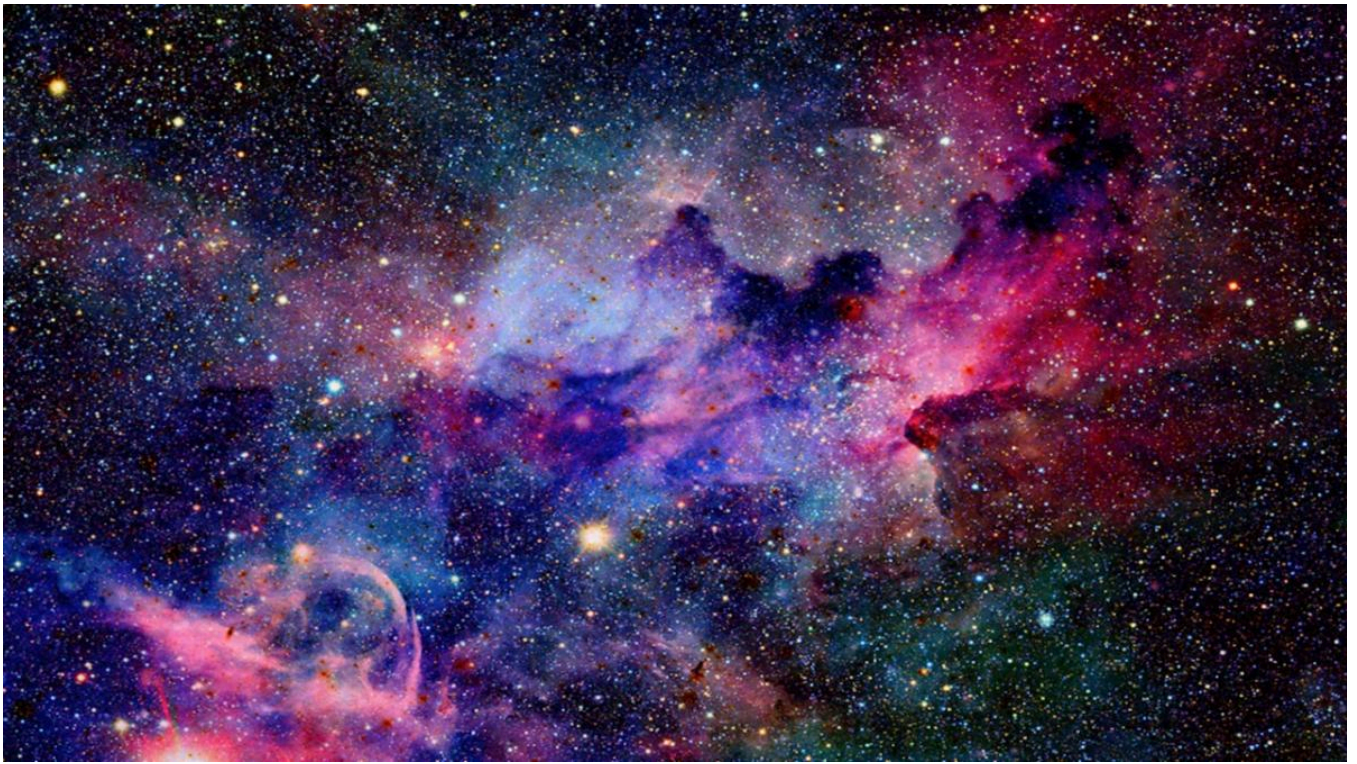



Windows (user-interface) Binary (bits). 4-Dimensional. Space-Time. Classical physics.

The "Main Frame"
(we don't know where the "computer" is yet or how it displays things to Windows) Quantum or ? based. Probability? Deterministic?

Steven Weinberg - How Many Universes Exist?



0:43 / 6:12



How many universes? Interview (https://r20.rs6.net/tn.jsp?f=001p69XCyoK1NDNrAZUv4F6wG9ChyI7WITsJzP_qonHW9yeQoDRr6lPwqE_WWO3bfosX-vstImkubwrLgG8kv7ALC3uwULR-QapX6ba43SMYPH8SP6cdNXK2IH2ipRDjoUuFI2o8hSh-H59cLIhfl5-PA==&c=&ch=) **with**
Steven Weinberg, recently deceased University of Texas Professor and Nobel Prize Winner in Physics.



How many universes? Interview (https://r2o.rs6.net/tn.jsp?f=001p69XCyoK1NDNrAZUv4F6wG9ChyI7WlTsJzP_qonHW9yeQoDRr6lPwocmKh3IdBuPB653Ajtq-Pln9jkYv3vjCQQf6dxrPti6YGPOECXLSb1tpv-UgYy6oZ5EJjiA2LxdEe9rayyMiEL7__Ti8IEq65EG4XEvpMclxAYa7nldHMSOpzFsVmmrK8ui4wFLdpNIhgX-f4HsgZJHtHK6VLkQA==&c=&ch=) with Max Tegmark, MIT Professor of Physics.

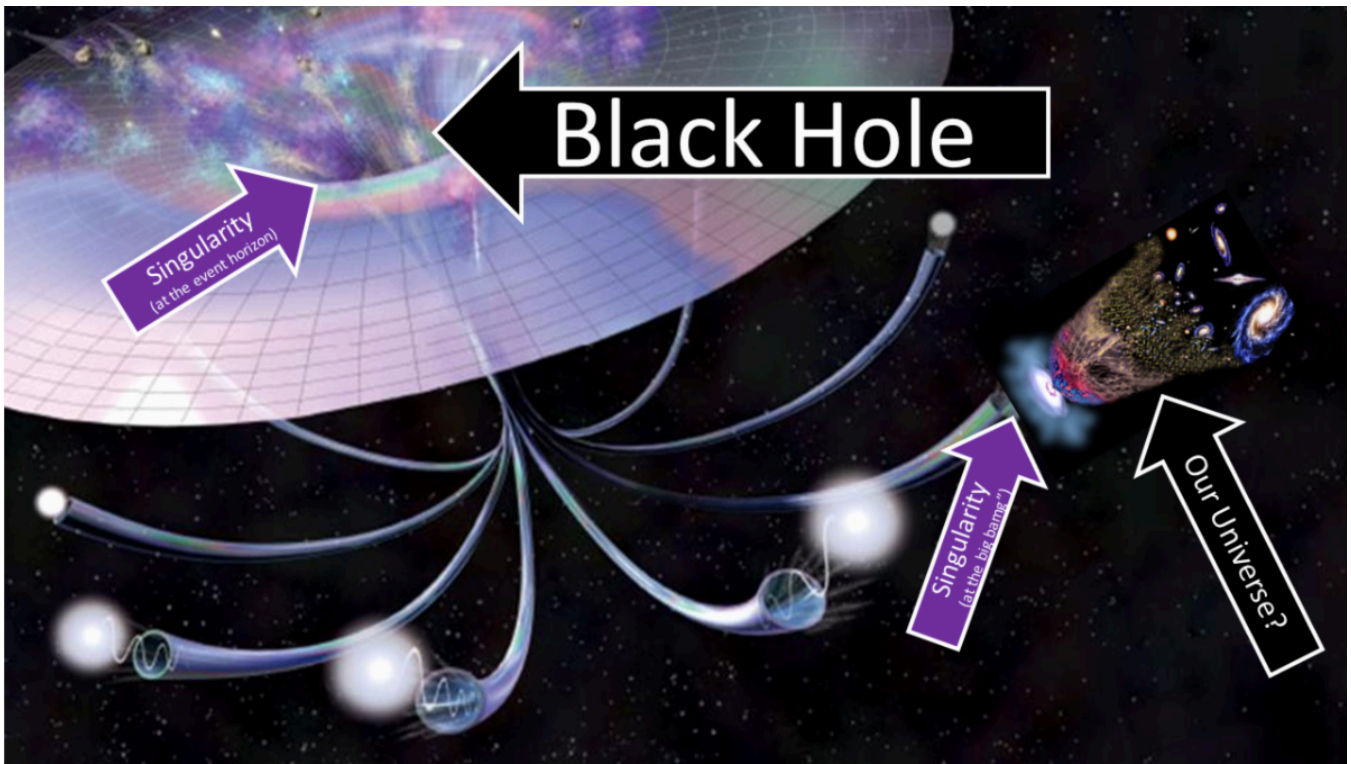

James Webb Space Telescope

---“Simplicity machine.”

- Jed Anderson



---“Looking back 13.8 billion years to find out what is controlling the happening of now. It’s simpler.” - Jed Anderson

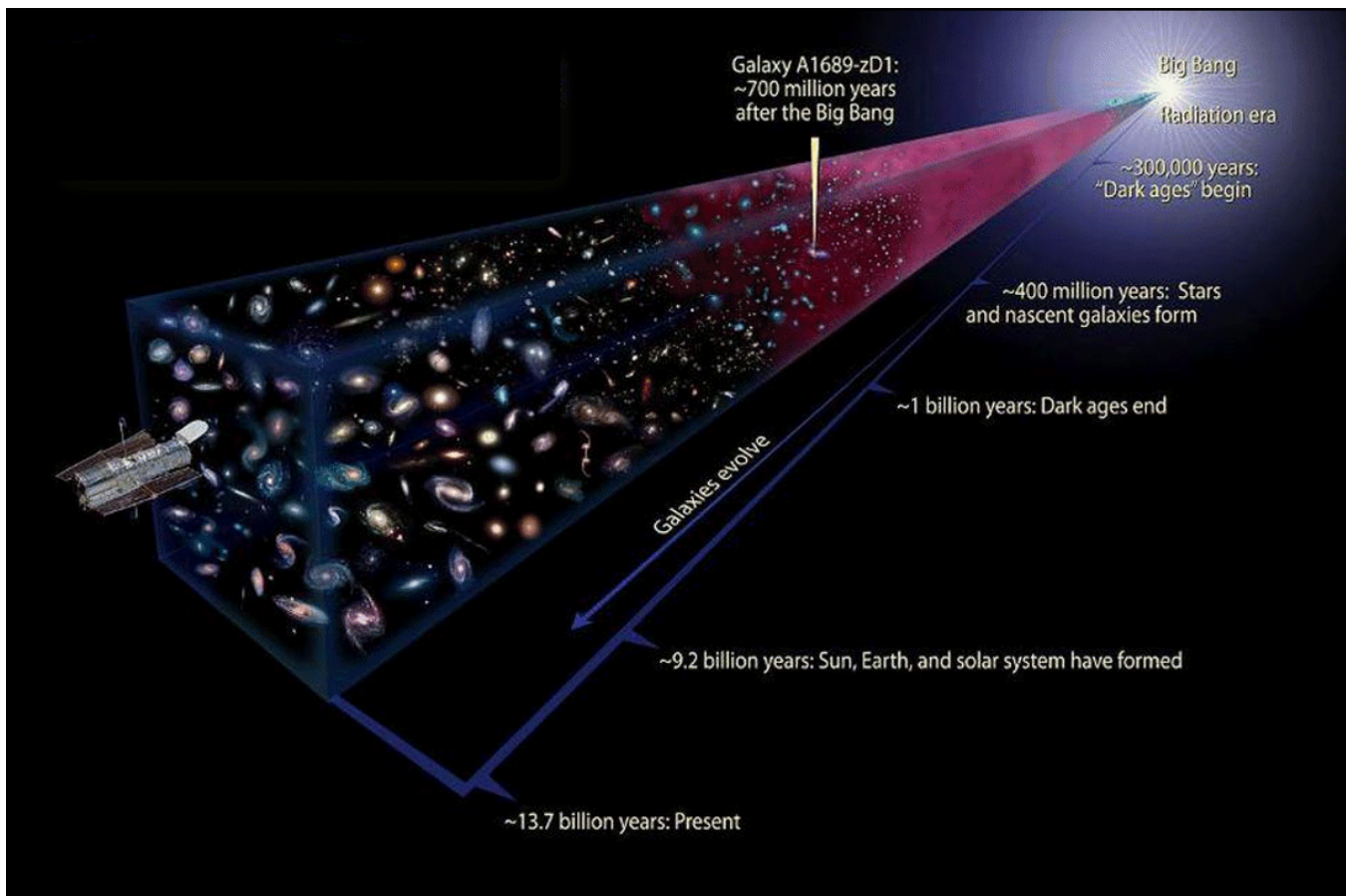

I'll explain why I think of the James Webb Space Telescope not only as a "time machine" as many people call it, but a "simplicity machine."

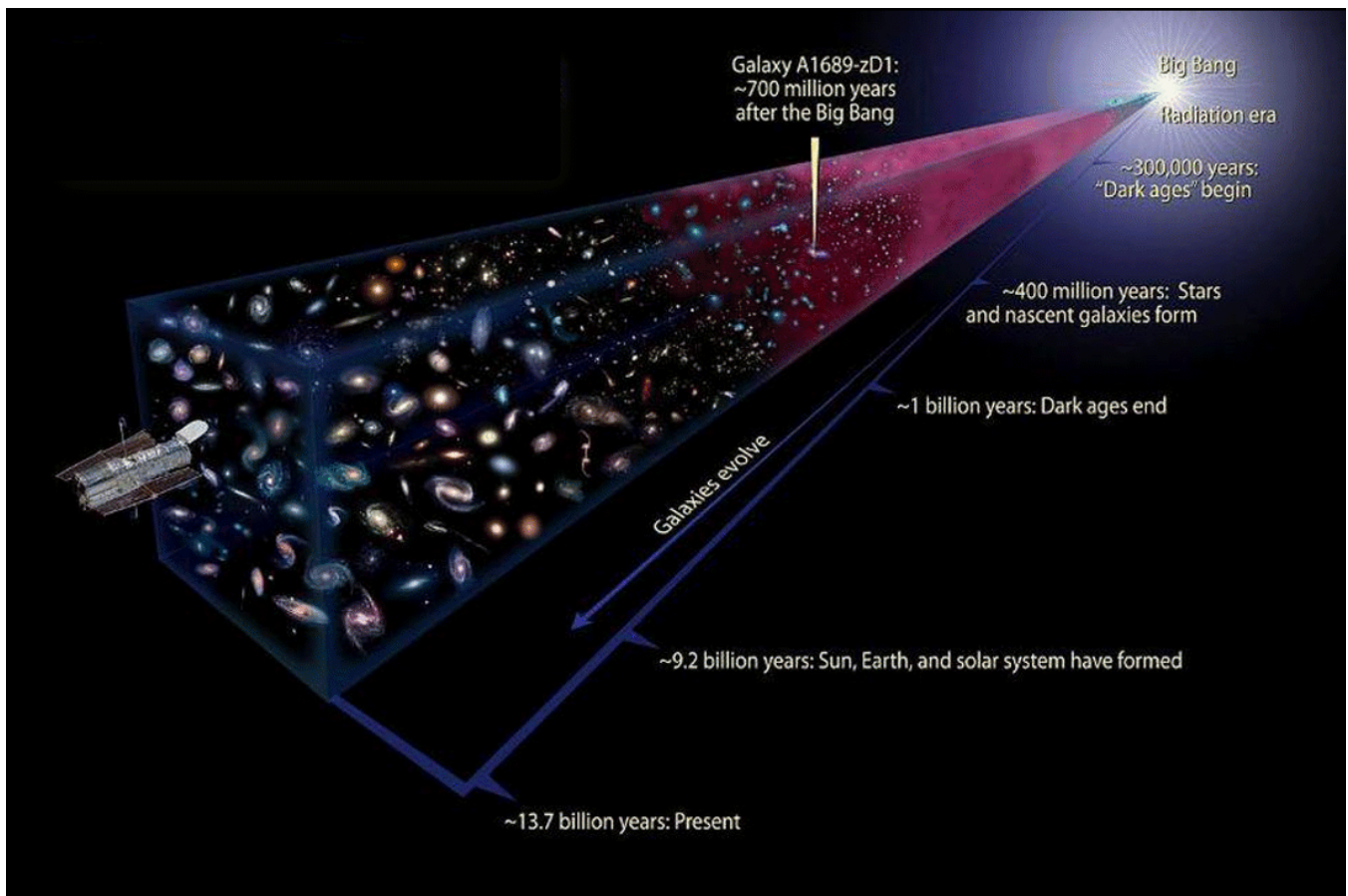

If you think of the universe as a computer, the longer the computer has run, the more data it generates, and the more difficult it becomes to sift through piles of data and phenomena to find the underlying patterns and laws.

But if you instead looked back when the computer had only run a couple times ... finding the underlying simplicity in the laws and patterns is much, much easier.

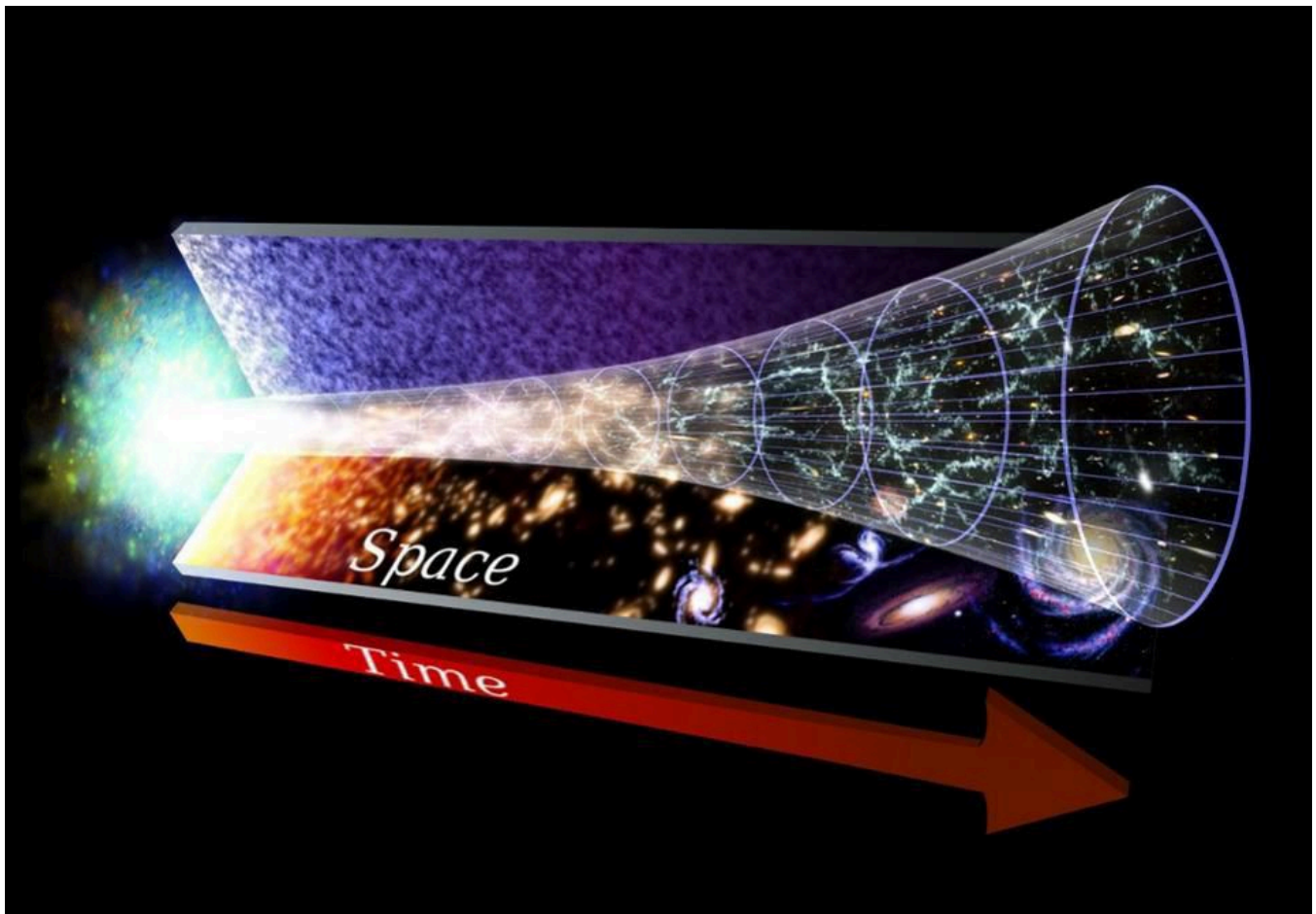

Here for example you can see Stephen Wolfram running very simple code 500 times ... and the extremely complicated resulting phenomena.

[Perhaps the easiest way to realize the complexity of phenomena from simple code is life. All life is just A-C-T-G. It's just the same 4 amino acids (DNA) in different combinations run trillions and trillions of times (evolution). That's it. It's so mind-bogglingly simple it's difficult to perceive its simplicity.]

Wolfram Desktop File Edit Insert Format Cell Graphics Evaluation Palettes Window Help

RulePlot[CellularAutomaton[30]]

Out[10]=

■ ■ ■ ■	■ ■ ■ ■	■ ■ ■ ■	■ ■ ■ ■	■ ■ ■ ■	■ ■ ■ ■	■ ■ ■ ■	■ ■ ■ ■
■	■	■	■	■	■	■	■

In[8]=

ArrayPlot[CellularAutomaton[90, {{1}, 0}, 300]]

Out[8]=

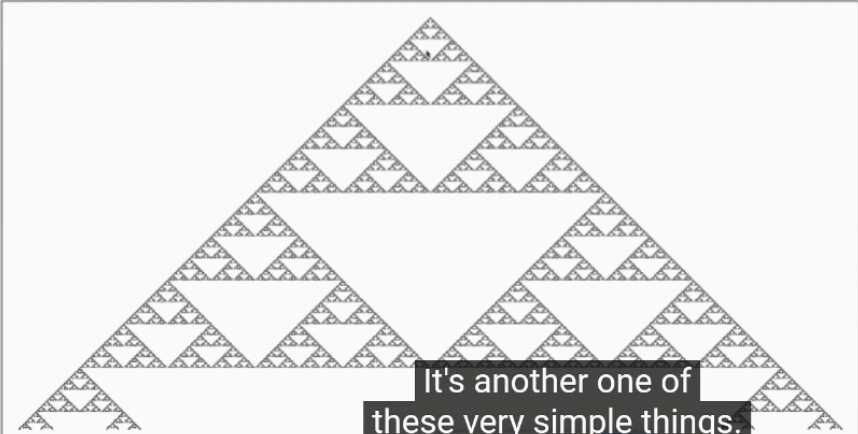

Steven Wolfram

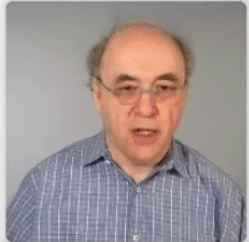

It's another one of these very simple things.

National Aeronautics and Space Administration



W E B B



THE JAMES WEBB SPACE TELESCOPE

www.exoplanets.nasa.gov
www.nasa.gov

See if you can find the pattern in this code:

213151819141

Pretty easy huh? The pattern or rule is that every other number is a 1. But if I added just 2 or 3 more rules and ran this code trillions of times for 13.8 billion years, it would be very difficult for anyone or any computer at this point in history to find the

original pattern, rule, or code.

“But ... if you looked at computer code after it only had been run a couple times, it would be much easier to find the simplicity in the underlying patterns and rules.”

- Jed Anderson, EnviroAI



---“Exciting days ahead for humanity.”- Jed Anderson, EnviroAI

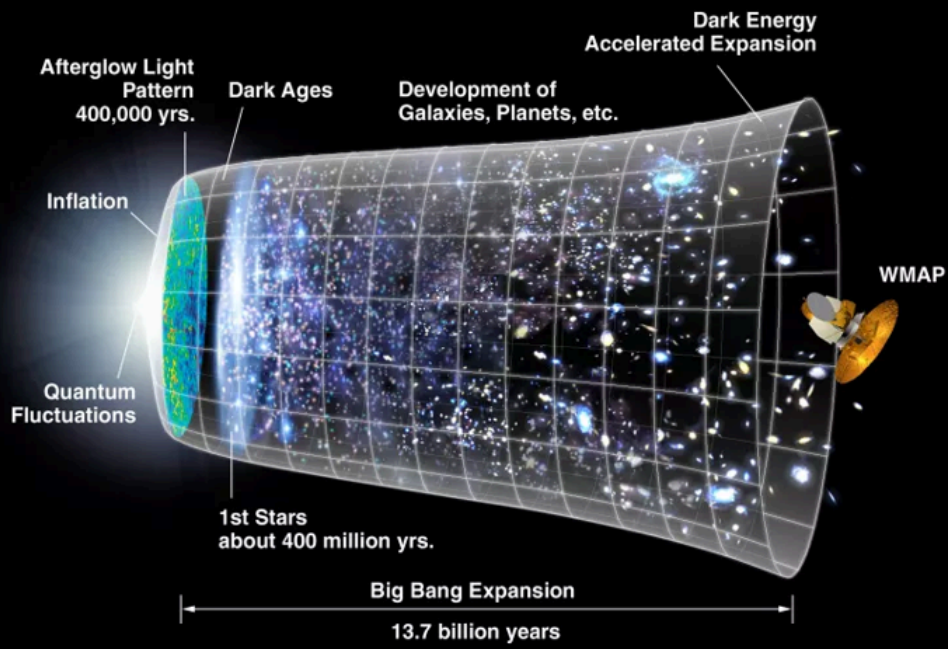

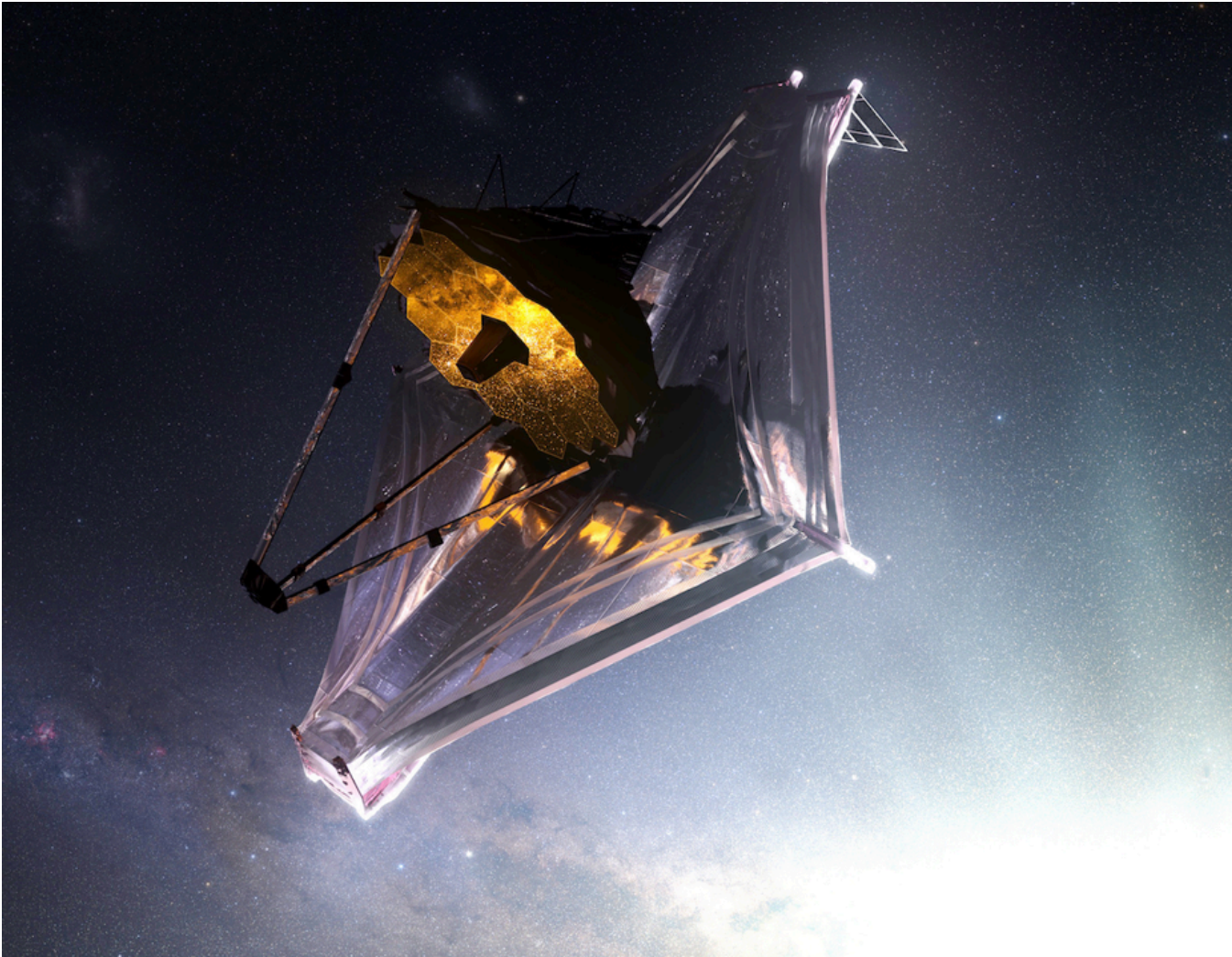

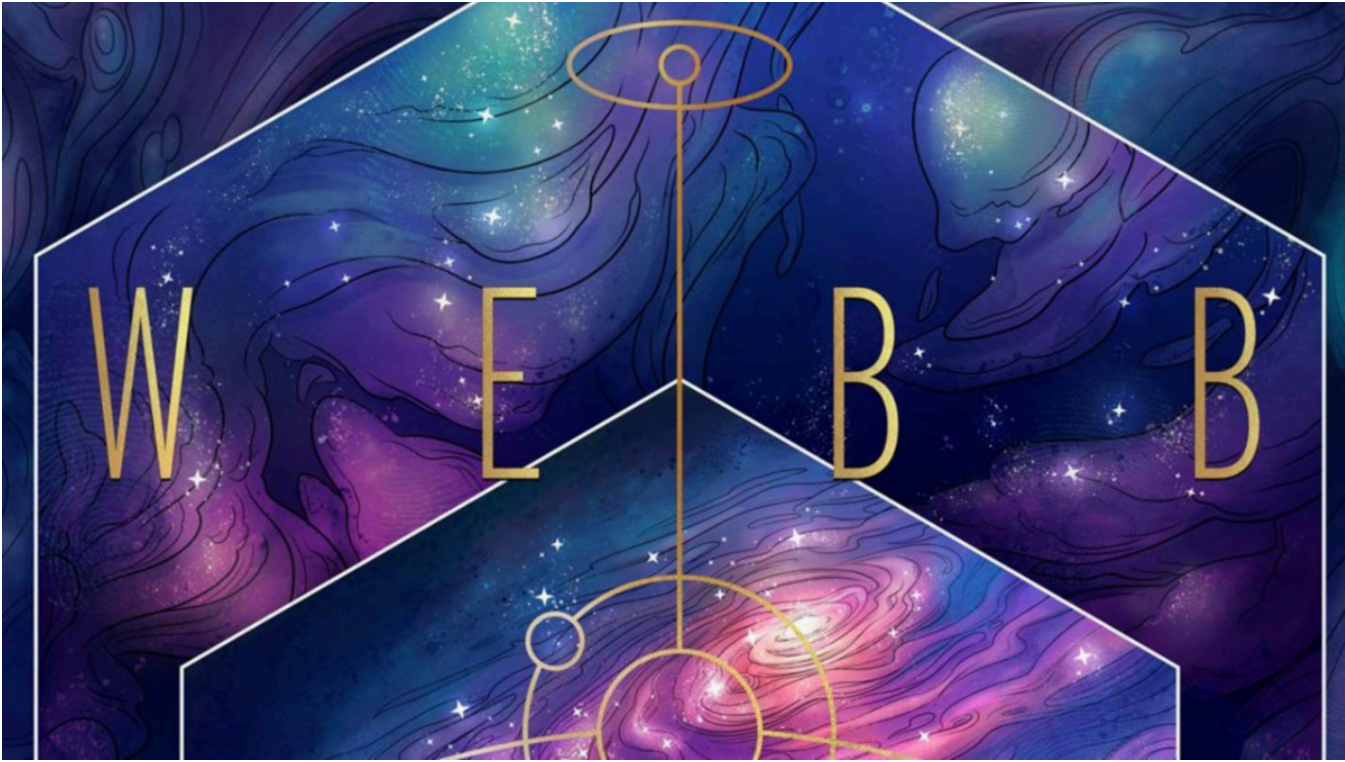

**Is the universe
simple?**



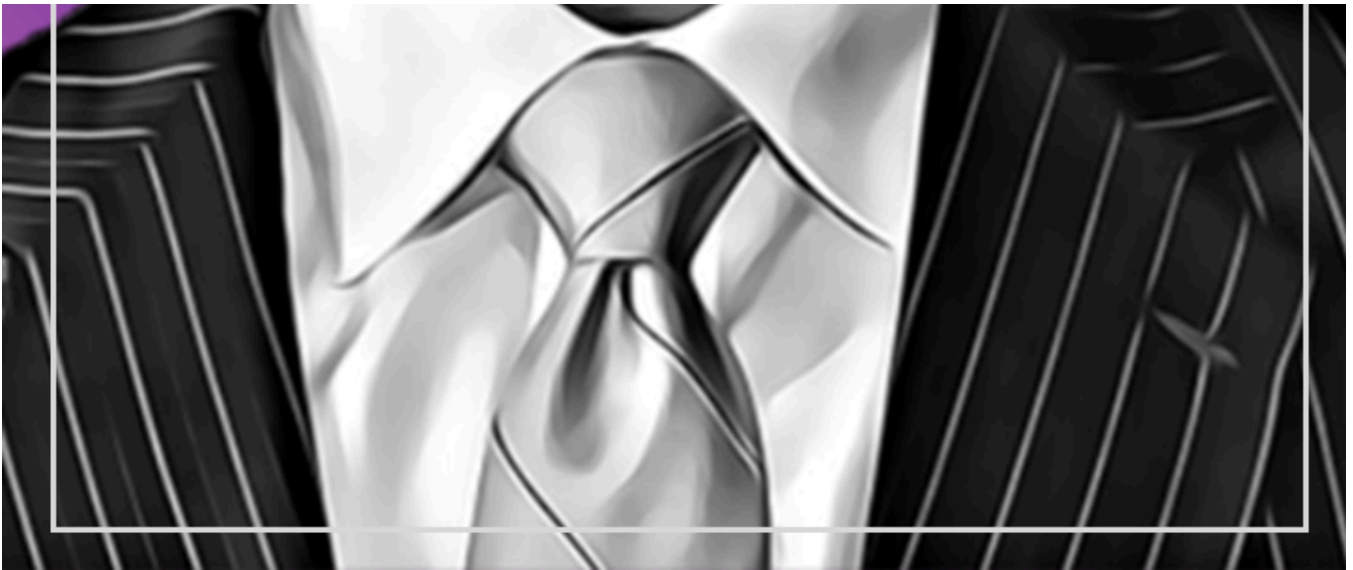

Simplicity.

---“Once we understand the simplicities, our creativity and imagination can go wild
... and we can begin to “play the universe”. - Jed Anderson, EnviroAI

---“The mind-bending discovery of Isaac Newton wasn’t a terrestrial force acting on an apple ... it was looking at the apple and then looking at the moon and everything in the universe, and with a serendipitous epiphany of inextricable simplicity thinking ... “It’s the same! It’s the same force. I can’t believe it! It’s the same force! It can’t be that simple. But it is that simple! It’s the same force!”

- Jed Anderson, EnviroAI

[The universe is simple - Richard Feynman \(https://r2o.rs6.net/tn.jsp?f=001p69XCyoK1NDNrAZUv4F6wG9ChyI7WITsJzP_qonHW9yeQoDRr6lPwsacDlBuVEOP-1ZPj2mqsPT698kgwwj7G8z_WIwkvHnyWodRIHkOPJIYC4SEctdar_mSYpY4dmqqAEYqOo9a2ZjGPTXsFeWVHnk8lCDyYYu&c=&ch=\)](https://r2o.rs6.net/tn.jsp?f=001p69XCyoK1NDNrAZUv4F6wG9ChyI7WITsJzP_qonHW9yeQoDRr6lPwsacDlBuVEOP-1ZPj2mqsPT698kgwwj7G8z_WIwkvHnyWodRIHkOPJIYC4SEctdar_mSYpY4dmqqAEYqOo9a2ZjGPTXsFeWVHnk8lCDyYYu&c=&ch=))



---“It[the universe] is not complicated ... it’s just a lot of it.”

---Richard Feynman

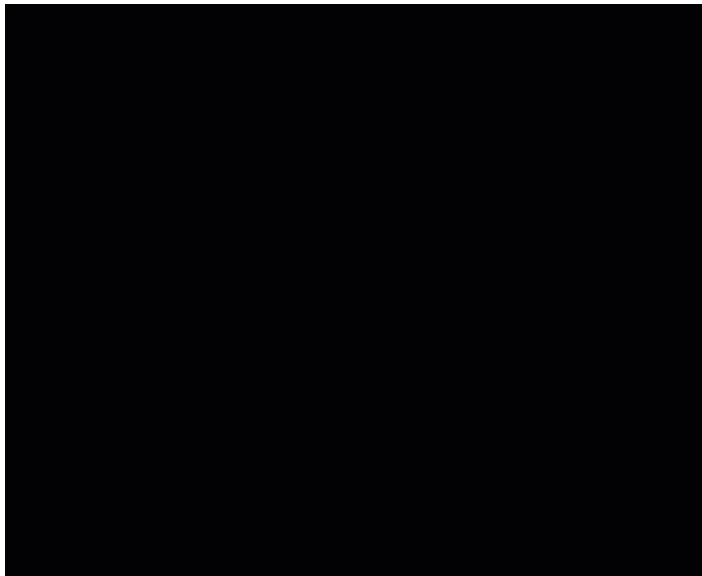

Simple start. Simple rules.

As you can see in the graphic below, everything in the universe can be traced back to a very simple start. Simple start. Simple rules. The more we understand the underlying simplicity in everything, the more we can create new phenomena with richer and more complicated attributes.

Reconstructing the Big Bang

The universe's first moments may have imprinted hidden patterns in the sky.

DOLLOPS OF DENSITY

At the universe's birth, pairs of particles continuously popped into existence.



THE BIG SPLITS

The inflating universe split these partners, creating dense spots that would one day become galaxies and galaxy clusters.

Big Bang

Time →

Exponential expansion

Dense spots in the universe

FIXED ENDING

Researchers can see only where the dense spots ended up. They hope to use the details of this pattern to understand the mysterious processes at work during inflation.

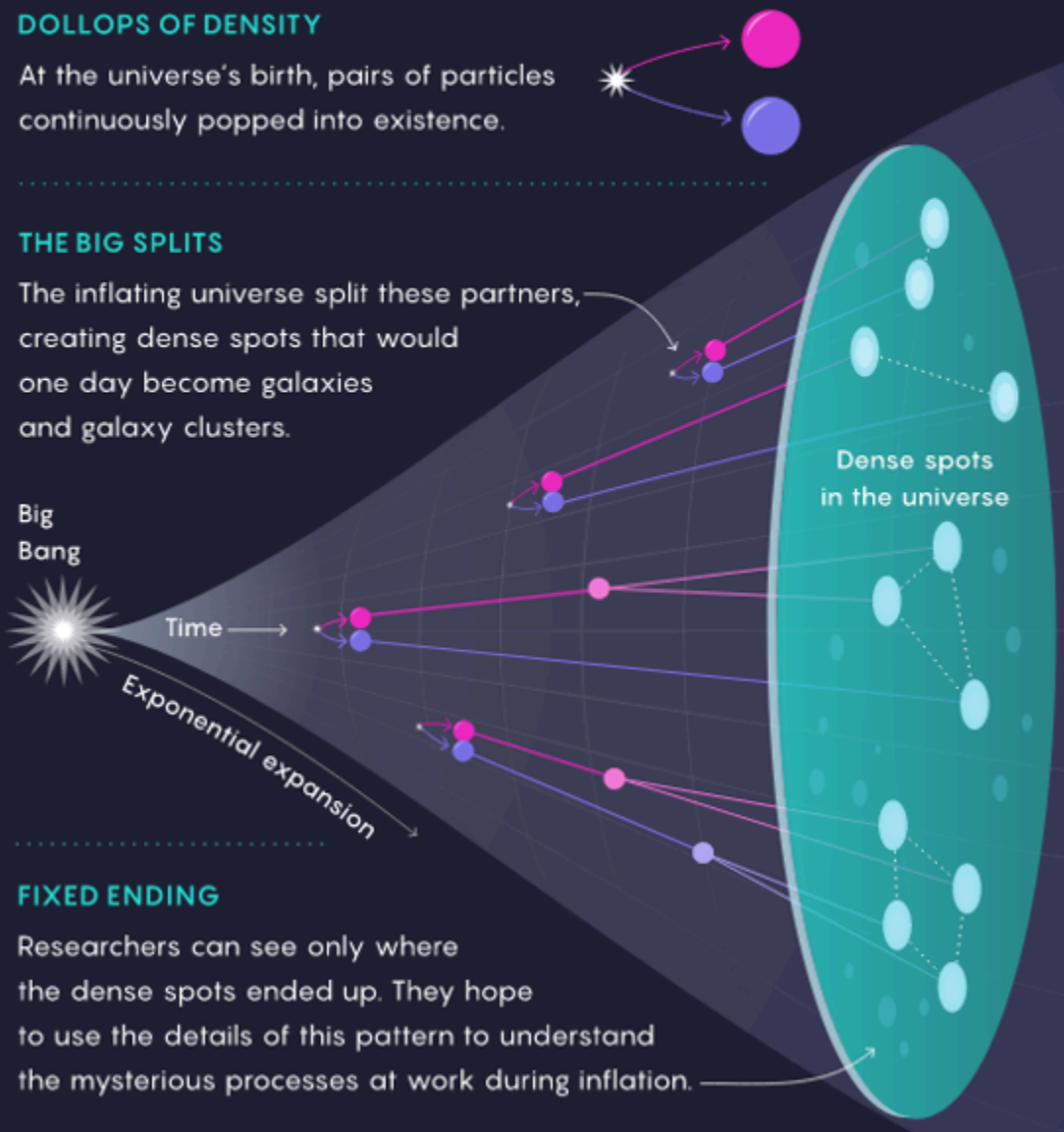



---“The more we understand the simplicity in everything around us ... the more we can produce richer and more complex phenomena.” - Jed Anderson, EnviroAI



Oscar Peterson’s ability to recognize patterns in nature and creatively rearrange them was scary. Scary. Oscar was a genius. Remember when you watch this solo, Oscar is only manipulating 12 notes. That’s it. Just 12 notes. It’s because Oscar

understood the simplicity that he was able to produce such complex phenomena (see below). Genius.

I personally think this is the greatest solo of all time (https://r20.rs6.net/tn.jsp?f=001p69XCyoK1NDNrAZUv4F6wG9ChyI7WITsJzP_qonHW9yeQoDRr6lPwjyythi_v7Jkcxyl6rnNo3mezDYWESTHm5JcOpx7dsb76V1B6JINucGL_89dhZ21ef6xfd1g2YW8OxOxZlHxSwiGfx4DA97Mvw==&c=&ch=). The chord and style changes are dizzying. Just try watching Oscar's brain as he is imagining and working through this. It leaves you breathless. And the reaction of the jazz greats he is playing with is priceless. Priceless. They seem to almost not believe what they are hearing.

**How simple can we
make protecting
nature?**



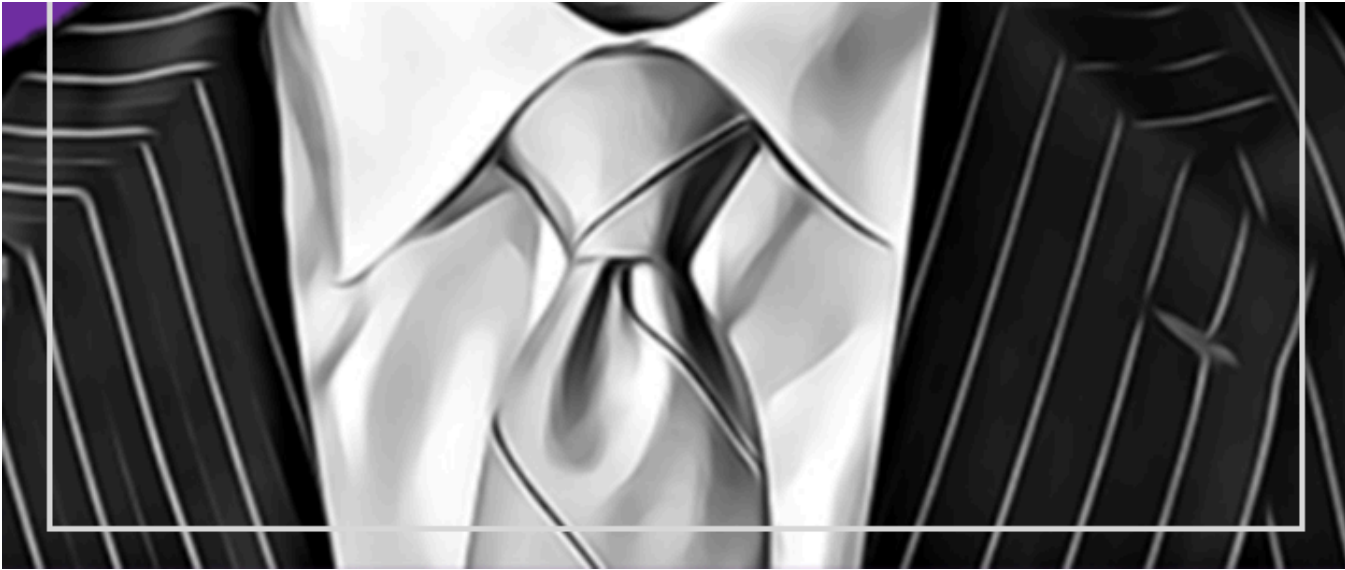

SIMPLE.



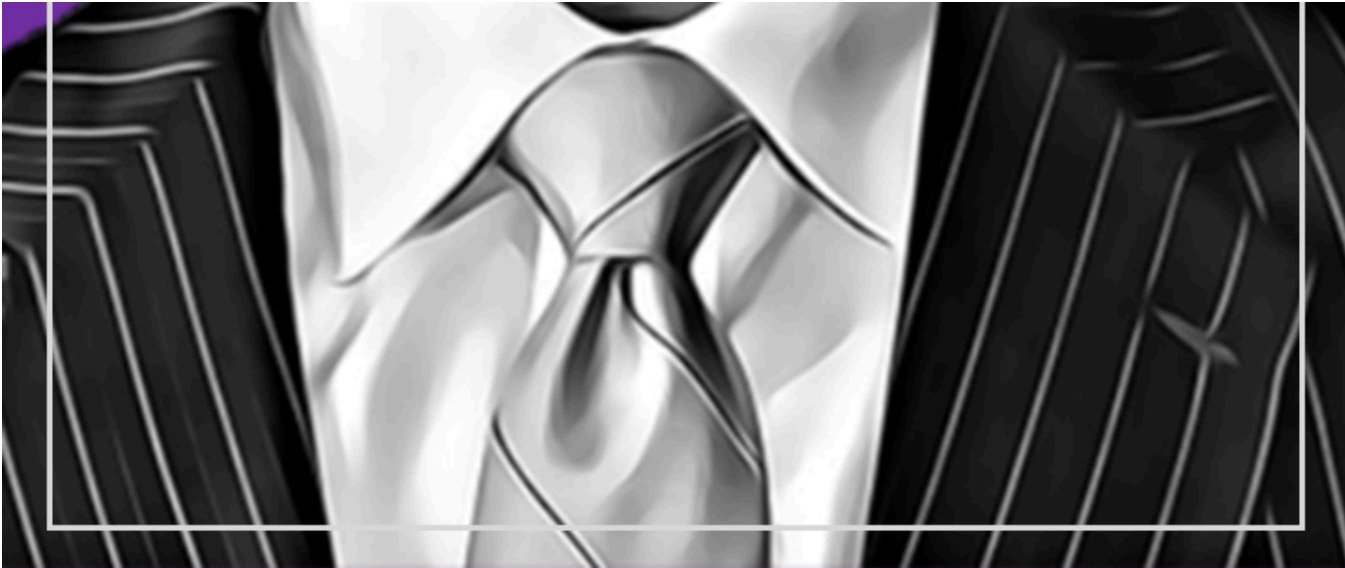

**Protecting
simplicity with
simplicity.**



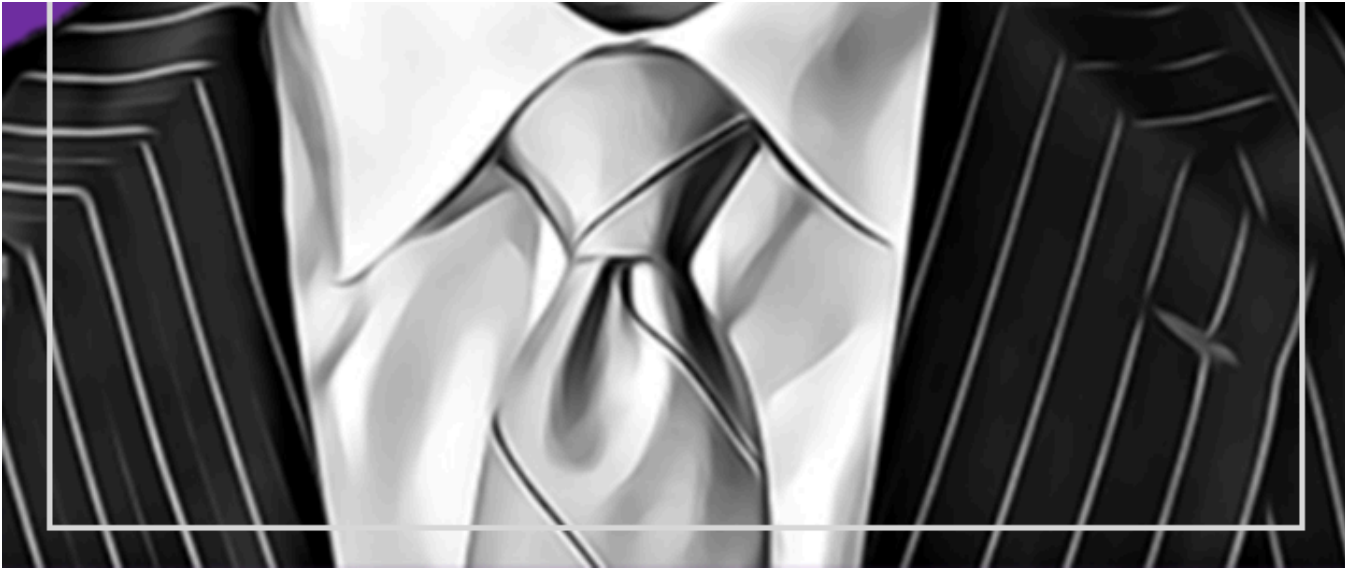

---“Simplification ... not only of the laws of physics ... but the laws of humankind.” -

Jed Anderson

---“Grace is not doing away with law. It’s fulfillment of law. It’s simplicity of law. ”

---“Law is good. But it is not the end. It’s only purpose is to point toward grace ...
toward something simpler and more profound.”

—“Grace is satisfaction of complicated don’ts with a simple do.”

---“Grace is the ultimate simplicity.”

- Jed Anderson



---“Everything is patterns.

Environmental protection, simply stated, is just identifying and protecting certain patterns in nature.

It really can be stated that simply.”

- Jed Anderson, EnviroAI



Quantum Data

1

Classical Data

(binary computer)

01001010010101
10101101110000
10011110000111
10101011111000
01010111100011
01010101010101
11010110101011

Biological Data

ACTGACTGACTTAGG
ATTCGAGATCCATTC
CTTGAGACCTTTTT
ACCCCTATAGCATCA
TTCCAGGATCTATTAT
CCTATATATAGGGGC
CCATATAAATGGGCT

Human Data

Language data (letters), sensory data (visual images), numeric data (numbers)

CONNECT THE DATA

Connect the data. See the patterns. Protect the patterns.

Notes are data. Music is patterns.

- Listen to a Bach fugue. Here is one of my favorites ([https://r20.rs6.net/tn.jsp?f=001p69XCyoK1NDNrAZUv4F6wG9ChyI7WlTsJzP_qonHW9yeQoDRr6lPwpvu9RHM9Mol8cX_wkcC8AstDBwEKh-lNeMmm5cGaVUgw6HG_KCU3a5GpWx8D-T-x5odvm5SbCq7aUJaFZBImntGKReETog-2J9-iUxXERVxfbdnFFP5jY-Yn11QIx-G9w==&c=&ch=\)](https://r20.rs6.net/tn.jsp?f=001p69XCyoK1NDNrAZUv4F6wG9ChyI7WlTsJzP_qonHW9yeQoDRr6lPwpvu9RHM9Mol8cX_wkcC8AstDBwEKh-lNeMmm5cGaVUgw6HG_KCU3a5GpWx8D-T-x5odvm5SbCq7aUJaFZBImntGKReETog-2J9-iUxXERVxfbdnFFP5jY-Yn11QIx-G9w==&c=&ch=)!))! **And then learn**

briefly how a fugue is written (https://r20.rs6.net/tn.jsp?f=001p69XCy0K1NDNrAZUv4F6wG9ChyI7WITsJzP_qonHW9yeQoDRr6lPwpvu9RHM9MolWlljzK1QQ-VPR7Aa69cUg3eUf1bgF4Zbp4l-6MSgStxT8CzmcOLqAAJoWrNv6V9msApuiLep5WGAreYZZTpV_4oCWvOjzrFUu091EKwTO2PRr_aOPn2UM2s-Yd81LQrlop7AhRobn--XZrooHG3qOjLkv_5C87ha&c=&ch). It's math. It's computation. Instead of using numbers, Bach is using notes corresponding to frequencies. Two books I would suggest. One is "Godel, Escher, Bach" by Douglas Hofstadter. The other is "J.S. Bach's Musical Offering" by H.T. David.

- Einstein said he didn't think in terms of math or words. He thought in terms of music.
- Pythagoras, the founder of mathematics, was said to have discovered mathematics when he noticed similarities between the sound of plucking a lyre string and the resonances made by hammering metal. He found that they created musical frequencies that vibrated with certain ratios that corresponded to patterns.
- "If we had a microscope powerful enough, we could see that electrons, quarks, neutrinos, etc. are nothing but vibrations on minuscule loops resembling rubber bands. If we pluck the rubber band enough times, and in different ways, we eventually create all the known subatomic particles in the universe. This means that all the laws of physics can be reduced to the harmonies of these strings. Chemistry is the melodies one can play on them. The universe is a symphony. And the mind of God, which Einstein eloquently wrote about, is cosmic music resonating throughout space-time." - Micho Kaku

$\pi \int_a^b f(x)^2 dx$

$e^{\sin x \ln(\sin x)}$

$e^{\pi i} + 1 = 0$

$\int \frac{3x^2 + 1}{x^3 + x} dx$

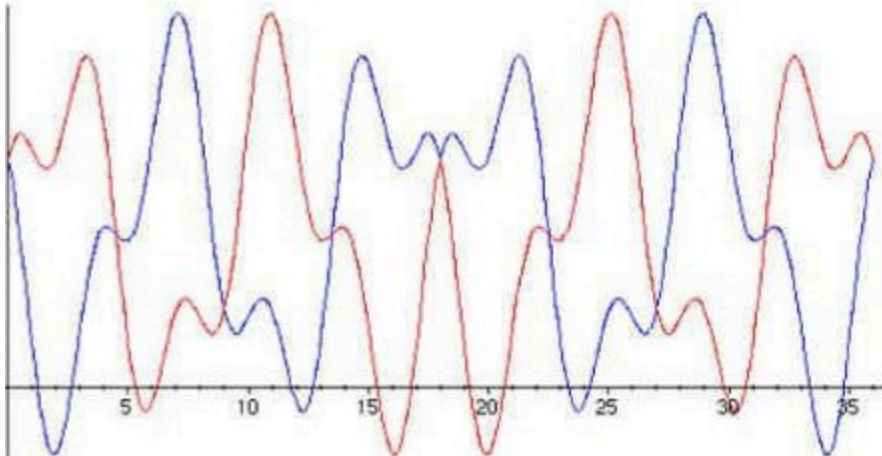

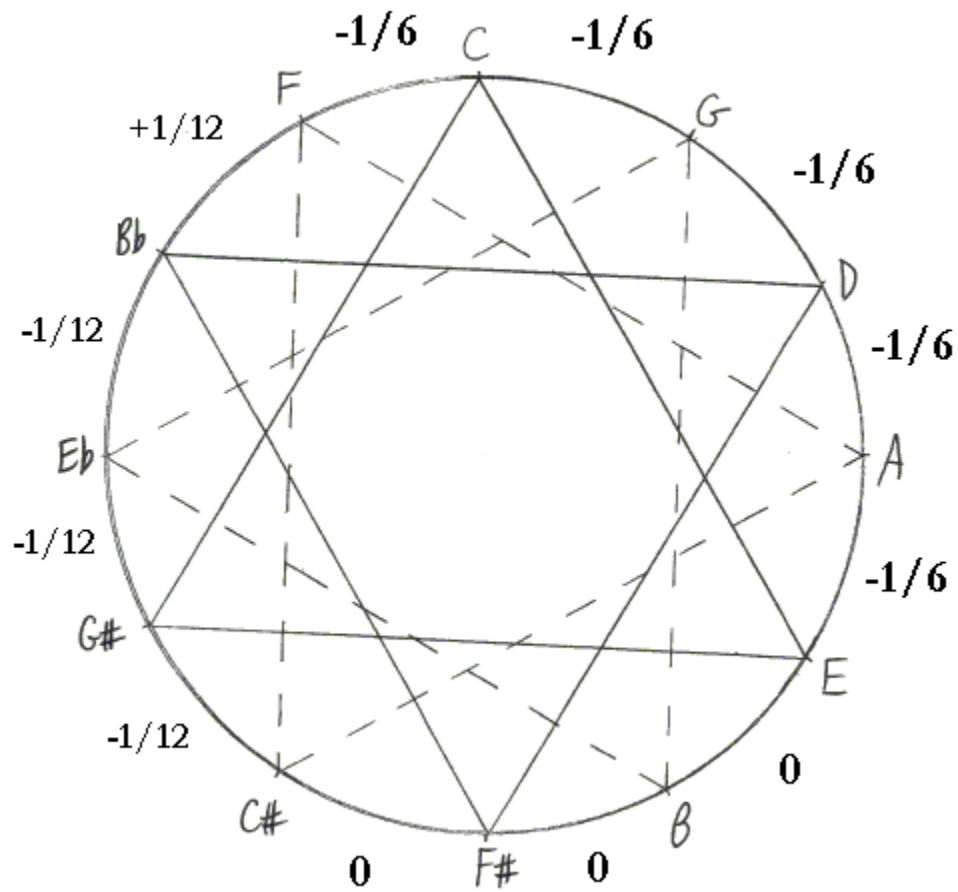

The music of the early universe---“chop-sticks” ...

Allegro

Piano *mf*

The first system of musical notation is for a piano piece in 3/4 time, marked *Allegro* and *mf*. It consists of two staves: a treble clef staff and a bass clef staff. The treble staff contains a sequence of quarter notes: C4, D4, E4, F4, G4, A4, B4, C5. The bass staff contains a sequence of quarter notes: C3, D3, E3, F3, G3, A3, B3, C4.

5

The second system of musical notation continues the piece from measure 5. It consists of two staves: a treble clef staff and a bass clef staff. The treble staff contains a sequence of quarter notes: C4, D4, E4, F4, G4, A4, B4, C5. The bass staff contains a sequence of quarter notes: C3, D3, E3, F3, G3, A3, B3, C4.

Same musical laws playing out 13.8 billion years later ...

... much more complicated resulting phenomena---Chopin's Etude Op. 10., No. 4,
Torrent

4. *con fuoco*
f *fp* *cresc.*



Nature = Simple Equations

Mathematical equations that explain nature we are finding are very simple:

Einstein's Special Relativity Equation

$$E=mc^2$$

Shrodinger's Equation (Probability Waves – Quantum)

$$i\hbar(\partial/\partial t)\Psi=\hat{H}\Psi$$

Nature = Simple Computations

Computational programs that explain nature we are finding are very simple:

1
RulePlot[C

SIMPLICITY

- “Nature operates in the shortest way possible.”---Aristotle
- “Phenomena complex—laws simple.”—Richard P. Feynman
- “When the solution is simple, God is answering.” —Albert Einstein
- “Nature is pleased with simplicity. And nature is no dummy.” — Isaac Newton

- “The main purpose of science is simplicity and as we understand more things, everything is becoming simpler.” – Edward Teller
- “Nature does not multiply things unnecessarily; that she makes use of the easiest and simplest means for producing her effects” –Galileo

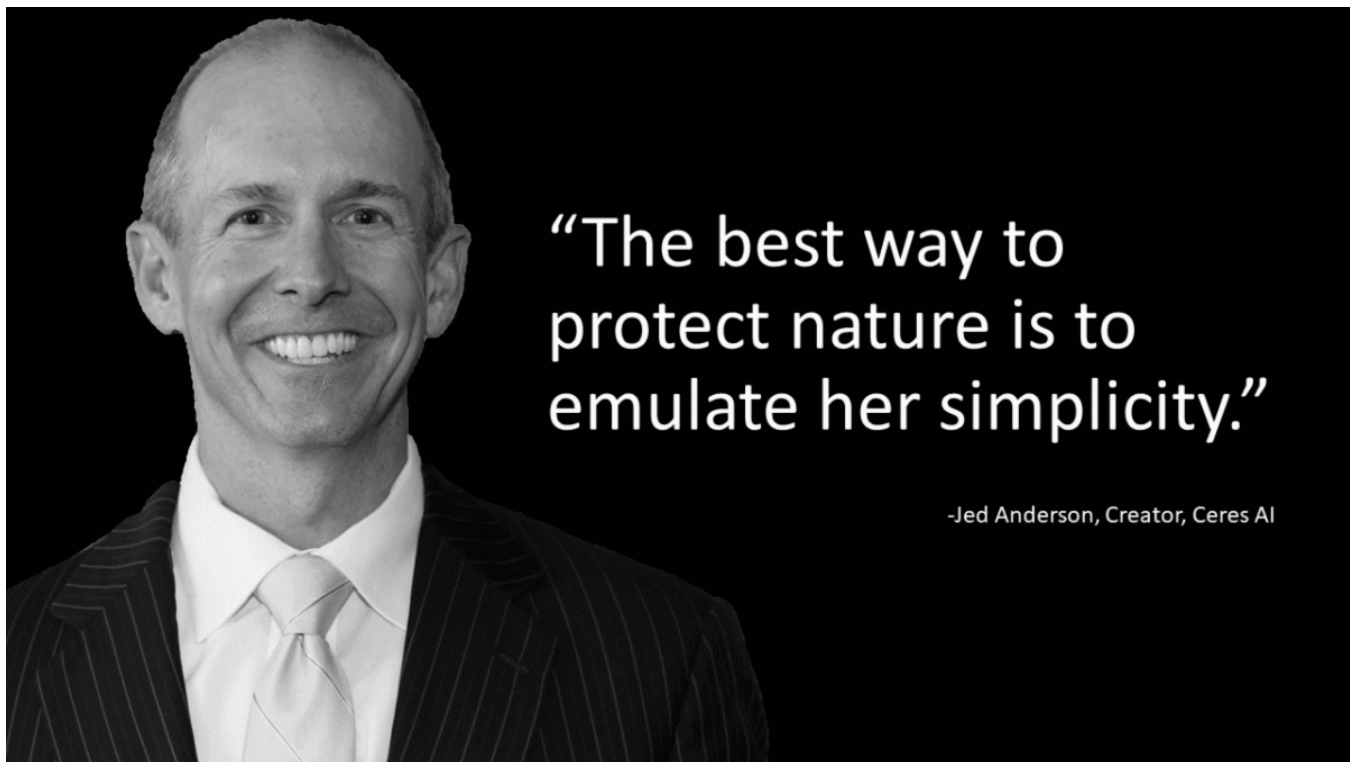

- “To be simple is to be great.” –Emerson
- “Rudiments or principles must not be unnecessarily multiplied –Immanuel Kant
- “There is no greatness where there is not simplicity.” – Leo Tolstoy
- “All the great things are simple.” –Winston Churchill
- “Out of clutter, find simplicity.” –Albert Einstein

- “AI is about making machines more fathomable and more under the control of human beings, not less. Conventional technology has indeed been making our environment more complex and more incomprehensible ...” - Donald Michie
- “Plurality should not be assumed without necessity.” —William of Ockham
- “Knowledge is a process of piling up facts; wisdom lies in their simplification.” ~ Martin H. Fischer
- “Complexity is your enemy. Any fool can make something complicated. It is hard to make something simple.”---Richard Branson.
- “The definition of genius is taking the complex and making it simple.” —Albert Einstein

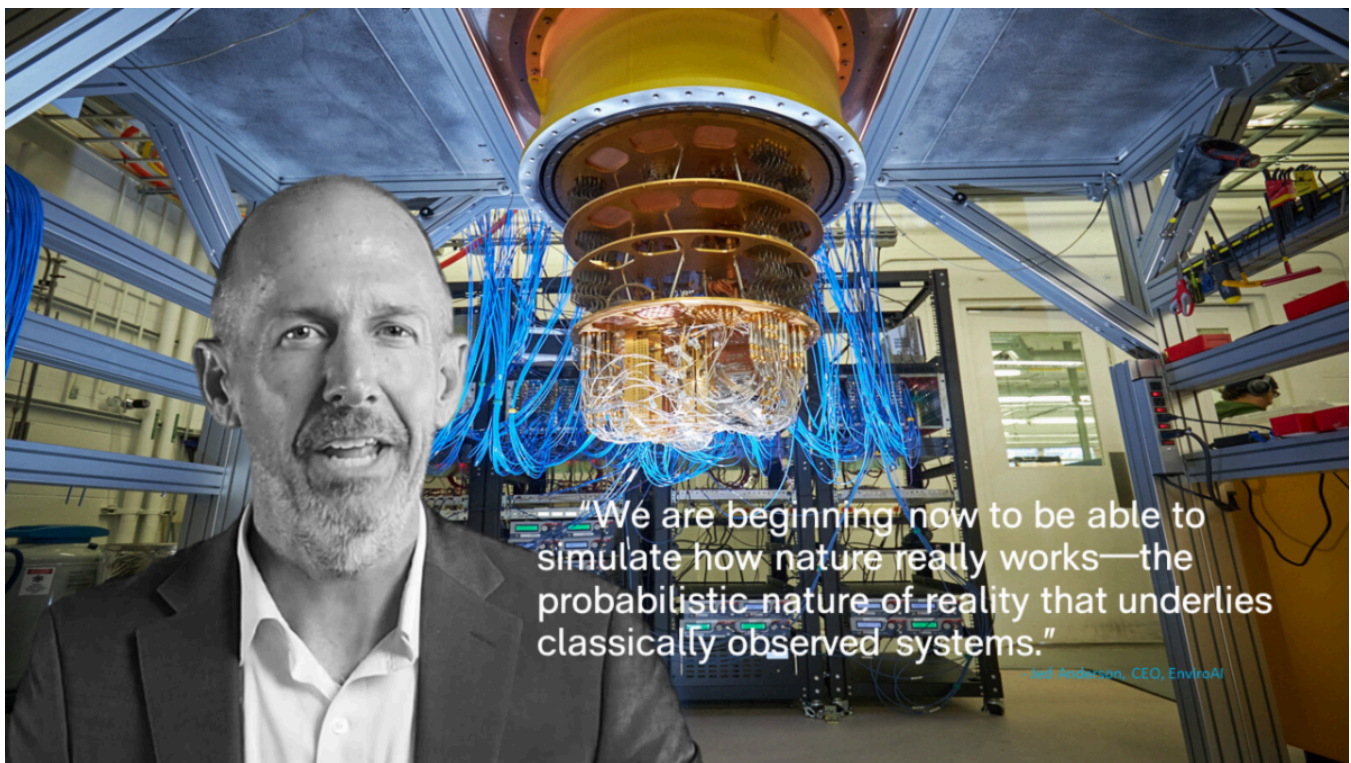

- “Beauty of style and harmony and grace and good rhythm depend on simplicity”—Plato

- “Simplicity is the ultimate sophistication.” – Leonardo da Vinci
- “Simplicity is the key to brilliance.” – Bruce Lee
- “Out of intense complexities, intense simplicities emerge.” – Winston Churchill
- “Simplicity, simplicity, simplicity!” – Henry David Thoreau
- “Simplicity is the glory of expression.” ~ Walt Whitman
- “Nothing is more simple than greatness; indeed, to be simple is to be great.” ~ Ralph Waldo Emerson
- “The great artist and thinker are the simplifiers.” – Henri Frederic Amiel
- “It is vain to do with more what can be done with less.” ~ William of Occam
- “Clutter and confusion are failures of design, not attributes of information.” ~ Edward Tufte
- “The most complicated skill is to be simple.” – Dejan Stojanovic
- “Fools ignore complexity. Pragmatists suffer it. Some can avoid it. Geniuses remove it.” – Alan Perlis

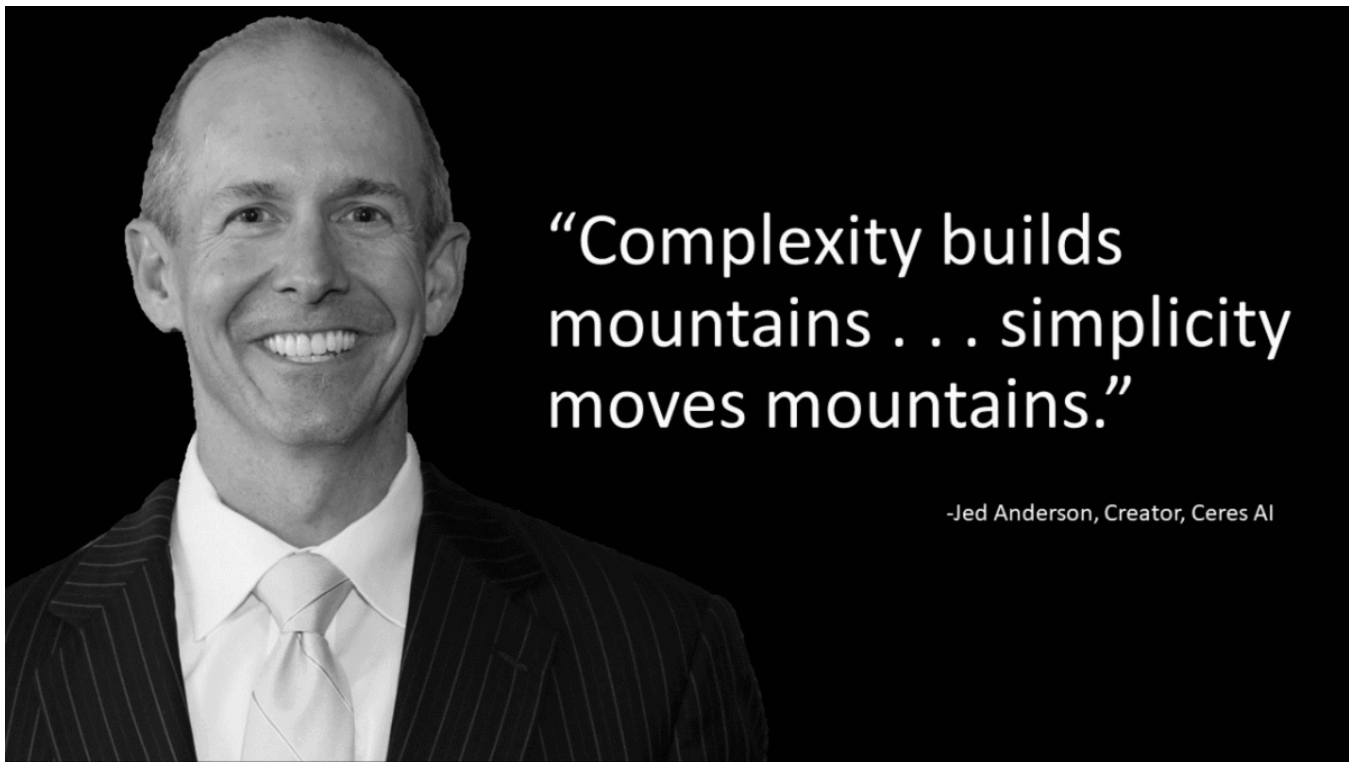

- “Truth is ever to be found in simplicity, and not in the multiplicity and confusion of things.” – Isaac Newton
- “It is always the simple that produces the marvelous.” – Amelia Barr
- “Simplicity is a prerequisite for reliability.” – Edsger Dijkstra
- “Almost all quality improvement comes via simplification of design, manufacturing, layout, processes, and procedures.” – Tom Peters
- “Simplicity is the most difficult thing to secure in this world; it is the last limit of experience and the last effort of genius.” – George Sand
- “Order and simplification are the first steps toward the mastery of a subject.” – Thomas Mann

- “Simplicity is the outcome of technical subtlety. It is the goal, not the starting point.” – Maurice Saatchi
- “The greatest ideas are the simplest.” – William Golding
- “People often associate complexity with deeper meaning, when often after precious time has been lost, it is realized that simplicity is the key to everything.” – Gary Hopkins
- “Growth creates complexity, which requires simplicity.” – Andy Stanley
- “Our life is frittered away by detail. Simplify, simplify.” – Henry David Thoreau
- “It is not a daily increase, but a daily decrease. Hack away at the inessentials.” – Bruce Lee
- “Complexity is impressive, but simplicity is genius.” – Lance Wallnau
- “Complexity is enemy of execution”. – Anthony Robbins
- “Simplicity will stand out, while complexity will get lost in the crowd.” – Kevin Barnett
- “Very often, people confuse simple with simplistic. The nuance is lost on most.” – Clement Mok
- “Anything simple always interests me.” – David Hockney
- “I would not give a fig for the simplicity this side of complexity, but I would give my life for the simplicity on the other side of complexity.” – Oliver Wendell Holmes

- “Any intelligent fool can make things bigger, more complex, and more violent. It takes a touch of genius...and a lot of courage to move in the opposite direction.”
~ E.F. Schumacher
- “The simple thing is the right thing.” ---Oscar Wilde
- “To simplify complications is the first essential of success.”—George Earle Buckle
- “You know you’ve achieved perfection in design, not when you have nothing more to add, but when you have nothing more to take away.”—Anotine de Saint-Exupery
- “A complex system that works is invariably found to have evolved from a simple system that worked. A complex system designed from scratch never works and cannot be patched up to make it work. You have to start over, beginning with a working simple system.”—John Gall
- “Although there are no textbooks on simplicity, simple systems work and complex don’t.” --Jim Gray
- “Simplicity does not precede complexity, but follows it.”- Alan J. Perlis
- “The simplest things are often the truest.”—Richard Bach
- “A lady once offered me a mat, but as I had no room to spare within the house, nor time to spare within or without to shake it, I declined it.” —Henry David Thoreau

- “Five lines where three are enough is stupidity. Nine pounds where three are sufficient is stupidity.”—Frank Lloyd Wright
- “Don’t be fooled by the many books on complexity or by the many complex and arcane algorithms you find in this book or elsewhere. Although there are no textbooks on simplicity, simple systems work and complex don’t.” —Jim Gray
- “When you first start off trying to solve a problem, the first solutions you come up with are very complex, and most people stop there. But if you keep going, and live with the problem and peel more layers of the onion off, you can often times arrive at some very elegant and simple solutions.”—Steve Jobs
- “I do believe in simplicity. [...] When the mathematician would solve a difficult problem, he first frees the equation of all incumbrances, and reduces it to its simplest terms. So simplify the problem of life, distinguish the necessary and the real. Probe the earth to see where your main roots run.” —Henry David Thoreau
- “Complexity is a sign of technical immaturity. Simplicity of use is the real sign of a well-designed product whether it is an ATM or a Patriot missile.”– Daniel T. Ling
- “[T]he grand aim of all science...is to cover the greatest possible number of empirical facts by logical deductions from the smallest possible number of hypotheses or axioms.”—Albert Einstein
- “Simplicity is the law of nature for men as well as for flowers.” —Henry David Thoreau

- “In building a statue, a sculptor doesn’t keep adding clay to his subject. Actually, he keeps chiselling away at the inessentials until the truth of its creation is revealed without obstructions.”—Bruce Lee
- “Simplifications have had a much greater long-range scientific impact than individual feats of ingenuity. The opportunity for simplification is very encouraging, because in all examples that come to mind the simple and elegant systems tend to be easier and faster to design and get right, more efficient in execution, and much more reliable than the more contrived contraptions that have to be debugged into some degree of acceptability.... Simplicity and elegance are unpopular because they require hard work and discipline to achieve and education to be appreciated.”— Edsger W. Dijkstra
- “I’ll tell you what you need to be a great scientist. You don’t have to be able to understand very complicated things. It’s just the opposite. You have to be able to see what looks like the most complicated thing in the world and, in a flash, find the underlying simplicity. That’s what you need: a talent for simplicity.”— Mitchell Wilson
- “Science may be described as the art of systematic over-simplification.”— Karl Popper
- “The ability to simplify means to eliminate the unnecessary so that the necessary may speak.” —Hans Hofmann
- “The field of Artificial Intelligence is set to conquer most of the human disciplines; from art and literature to commerce and sociology; from computational biology and decision analysis to games and puzzles.” —Anand Krish

- “A year spent in artificial intelligence is enough to make one believe in God.”— Alan Perlis
- “The whole world is certainly heading for a great simplicity, not deliberately, but rather inevitably. The simplicity towards which the world is driving is the necessary outcome of all our systems and speculations and of our deep and continuous contemplation of things. For the universe is like everything in it; we have to look at it repeatedly and habitually before we see it. It is only when we have seen it for the hundredth time that we see it for the first time. The more consistently things are contemplated, the more they tend to unify themselves and therefore to simplify themselves. The simplification of anything is always sensational. [...] Few people will dispute that all the typical movements of our time are upon this road towards simplification. Each system seeks to be more fundamental than the other; each seeks, in the literal sense, to undermine the other. In art, for example, the old conception of man, classic as the Apollo Belvedere, has first been attacked by the realist, who asserts that man, as a fact of natural history, is a creature with colourless hair and a freckled face. Then comes the Impressionist, going yet deeper, who asserts that to his physical eye, which alone is certain, man is a creature with purple hair and a grey face. Then comes the Symbolist, and says that to his soul, which alone is certain, man is a creature with green hair and a blue face. And all the great writers of our time represent in one form or another this attempt to reestablish communication with the elemental, or, as it is sometimes more roughly and fallaciously expressed, to return to nature. [...] But the giants of our time are undoubtedly alike in that they approach by very different roads this conception of the return to simplicity. Ibsen returns to nature by the angular exterior of fact, Maeterlinck

by the eternal tendencies of fable. Whitman returns to nature by seeing how much he can accept, Tolstoy by seeing how much he can reject.” – G.K. Chesterton





---“Identifying patterns in nature is powerful, but what will really be powerful is identifying the probability of patterns in nature prior to decoherence.”

- Jed Anderson, EnviroAI

---“We are all agreed that your theory is crazy. The question which divides us is whether it is crazy enough to be right.” – Niels Bohr

“The visible world is a daily miracle, for those who have eyes and ears.” – Edith Warton

“The most exciting phrase to hear in science, the one that heralds the most discoveries, is not “Eureka!” (I found it!) but “That’s funny...” Isaac Asimov

“As usual, nature’s imagination far surpasses our own, as we have seen from the other theories which are subtle and deep.”—Richard P. Feynman

I

“What if everything is an illusion and nothing exists? In that case, I definitely overpaid for my carpet.” —Woody Allen

“The imagination of nature is far, far greater than the imagination of man.” - Richard Feynman

“The whole question of imagination in science is often misunderstood by people in other disciplines. ... They overlook the fact that whatever we are allowed to imagine in science must be consistent with everything else we know.”—Richard P. Feynman

“In a world where everything is ridiculous, nothing can be ridiculed. You cannot unmask a mask.” - GK Chesterton

“I remember discussions with Bohr which went through many hours till very late at night and ended almost in despair; and when at the end of the discussion I went alone for a walk in the neighboring park I repeated to myself again and again the question: Can nature possibly be so absurd as it seemed to us in these atomic experiments?”

Werner Heisenberg

“At any rate, it seems that the laws of physics present no barrier to reducing the size of computers until bits are the size of atoms, and quantum behavior holds dominant sway.” Richard Feynman

“Progress in Science consists in seeing what everyone else has seen, but thinking what no one else has thought.” Szent-Gyorgi

“Our imagination is stretched to the utmost, not, as in fiction, to imagine things which are not really there, but just to comprehend those things which are there.”
Richard Feynman

“The point is no longer that quantum mechanics is an extraordinarily (and for Einstein, unacceptably) peculiar theory, but that the world is an extraordinarily peculiar place.” N. David Mermin

“The only ‘failure’ of quantum theory is its inability to provide a natural framework for our prejudices about the workings of the Universe.” Wojciech Zurek

“Everything we call real is made of things that cannot be regarded as real.” —Niels Bohr

---“The fact that we live at the bottom of a deep gravity well, on the surface of a gas covered planet going around a nuclear fireball 90 million miles away and think this to be normal is obviously some indication of how skewed our perspective tends to be.”— Douglas Adams

“Those who are not shocked when they first come across quantum theory cannot possibly have understood it.” —Niels Bohr

“If you are not completely confused by quantum mechanics, you do not understand it.” —John Wheeler

“I do not like [quantum mechanics], and I am sorry I ever had anything to do with it.” —Erwin Schrödinger

“Quantum mechanics makes absolutely no sense.” —Roger Penrose

“It is safe to say that nobody understands quantum mechanics.” —Richard Feynman

Superpositions have no classical interpretation. They are sui generis, an intrinsically quantum-mechanical construct... N. David Mermin

The nature of the relationships which the superposition principle requires to exist between the states of any system is of a kind that cannot be explained in terms of familiar physical concepts. One cannot in the classical sense picture a system being partly in each of two states and see the equivalence of this to the system being completely in some other state. There is an entirely new idea involved, to which one must get accustomed and in terms of which one must proceed to build up an exact mathematical theory, without having any detailed classical picture. P. A. M. Dirac

Quantum mechanics is magic. Daniel Greenberger

So long as we can find no better alternative to quantum mechanics we have to accept that it supplies little, if anything, beyond a superlative procedure for making calculations. A. B. Pippard, *Eur. J. Phys.* 7, 43-48 (1986)

The point is no longer that quantum mechanics is an extraordinarily (and for Einstein, unacceptably) peculiar theory, but that the world is an extraordinarily peculiar place. N. David Mermin

The only ‘failure’ of quantum theory is its inability to provide a natural framework for our prejudices about the workings of the Universe. Wojciech Zurek

Progress in Science consists in seeing what everyone else has seen, but thinking what no one else has thought. Szent-Gyorgi

Science is basically an artistic endeavor. It has all the freedom of any other imaginative endeavor. The artist and the scientist both live at the edge of mystery, surrounded by it. Both struggle to make order out of chaos. Jacob Bronowski

At any rate, it seems that the laws of physics present no barrier to reducing the size of computers until bits are the size of atoms, and quantum behavior holds dominant sway. Richard Feynman, *Foundations of Physics*, 16, 530 (1986).

However, once scientists adjusted to quantum jumps, superpositions, and apparent action at a distance, they stopped asking why small things didn't behave like big things, and started wondering why big things didn't act like small things. The general conclusion was that macroscopic systems decohere rapidly, and that this dilution of quantumness is responsible for the apparently 'normal' behaviour. Cummins and Jones *Contemporary Physics* 41, 387 (2000).

Bohr was inconsistent, unclear, willfully obscure and right. Einstein was consistent, clear, down-to-earth and wrong. John Bell to Graham Farmelo

If one person made it respectable once more for physicists to think about and study the meaning of quantum mechanics, it would be John Bell. Whereas Niels Bohr enveloped the mysteries of quantum mechanics in a web of words as enigmatic and ambiguous as the subject he sought to explain, smothering his readers in a blanket of reassurance that warded off misunderstanding by the indirect expedient of creating a beguiling darkness that set in precisely at the point where one should want more light, and leading more than a few students of physics to conclude - not without, one may suppose, a dim sense of betrayal for how could a loyal apprentice admit the master's thick blandishments to conceal not great wisdom but the implicit acknowledgment of failure? - that his pronouncements had begun to resemble what

Thomas Hardy said was the prose of Henry James, that is, a ponderously warm manner of saying nothing in infinite sentences, Bell pursued clarity above all. David Lindley, "Where Does the Weirdness Go?", page 127.

Anybody who's not bothered by Bell's theorem has to have rocks in his head. Distinguished Princeton Physicist to distinguished Cornell Physicist N. David Mermin

I think that a particle must have a separate reality independent of measurements. That is, an electron has spin, location and so forth even when it is not being measured. I like to think the moon is there even if I am not looking at it. Albert Einstein

We now know that the moon is demonstrably not there when nobody looks. N. David Mermin

Sometimes it seems to me that a bond between two atoms has become so real, so tangible, so friendly, that I can almost see it. Then I awake with a little shock, for a chemical bond is not a real thing. It does not exist. No one has ever seen one. No one ever will. It is a figment of our own imagination... Here is a strange situation. The tangible, the real, the solid, is explained by the intangible, the unreal, the purely mental. Charles A. Coulson

We do not know: we can only guess. And our guesses are guided by a faith in the orderliness of nature and that this orderliness can be comprehended by the human mind. Karl Popper

---"We are perhaps not far removed from the time when we shall be able to submit the bulk of chemical phenomena to calculation." Joseph Louie Gay-Lussac (1888)

“Now we come to the heart of chemistry. If we can understand what holds atoms together as molecules we may also start to understand why, under certain conditions, old arrangements change in favor of new ones. We shall understand structure, and through structure, the mechanism of change.” P. W. Atkins *Molecular Quantum Mechanics*, 1983, p. 250.

We virtually ignore the astonishing range of scientific and practical applications that quantum mechanics undergirds: today an estimated 30 percent of the U.S. gross national product is based on inventions made possible by quantum mechanics, from semiconductors in computer chips to lasers in compact-disc players, magnetic resonance imaging in hospitals, and much more. Max Tegmark and John Archibald Wheeler *Scientific American*, February 2001

However frustrating to our intuition, a necessary condition for the interference of a quantum “with itself” is that the experiment be such that it is impossible, even in principle, to obtain information on the particular path the quantum has taken. In other words, quantum systems, which left alone, follow the proverbial policy of “don’t ask, don’t tell!” J.G. Roederer, *Information and Its Role in Nature*, 2005.

The universe...stands continually open to our gaze, but it cannot be understood unless one first learns to comprehend the language and interpret the characters in which it is written. It is written in the language of mathematics... Galileo *Il Saggiatore* (1623)

I don’t demand that a theory correspond to reality because I don’t know what it is. Reality is not a quality you can test with litmus paper. All I’m concerned with is that the theory should predict the results of experiment. Stephen Hawking

Meaning does not reside in the mathematical symbols. It resides in the cloud of thought enveloping these symbols. It is conveyed in words; these assign meaning to the symbols. Marvin Chester, Primer of Quantum Mechanics.

Everything in the future is a wave, everything in the past is a particle. Lawrence Bragg

One of the characteristic features of quantum theory is wave-particle duality, i.e., the ability of matter or light quanta to demonstrate the wave-like property of interference, and yet to appear subsequently in the form of localized particles, even after the interference has taken place. David Bohm (slightly modified by FR)

We may regard the present state of the universe as the effect of its past and the cause of its future. Laplace

In classical physics, the past is assumed to exist as a definite series of events, but according to quantum physics, the past, like the future, is indefinite and exists only as a spectrum of possibilities. Even the universe as a whole has no single past or history. Hawking & Mlodinow, Scientific American, October 2010.

In the quantum world the present does not necessarily have a unique past.

If we want to describe what happens in an atomic event, we have to realize that the word “happens” can only apply to the observation, not to the state of affairs between two observations. Heisenberg (1958)

Quantum mechanics permits the cancellation of possibilities. Nick Herbert, Quantum Reality

How awkward is the human mind in divining the nature of things, when forsaken by the analogy of what we see and touch directly. Ludwig Boltzmann

Whoever endows Y with more meaning than is needed for computing observable phenomena is responsible for the consequences ... N. G. van Kampen

The nanoscopic world is not a miniaturization of the macroscopic world.

...quantum mechanics places the observer in the situation of Plato's prisoner - chained in a cave so he can see only the shadows of objects outside the cave, not the objects themselves. Leibfried, Pfau, Monroe *Physics Today*, April 1998, page 24.

A quon is any entity, no matter how immense, that exhibits both wave and particle aspects in the peculiar quantum manner. Nick Herbert, *Quantum Reality*, page 64.

A non-local interaction links up one location with another without crossing space, without decay, and without delay. A non-local event is, in short, unmediated, unmitigated and immediate. Nick Herbert, *Quantum Reality*, page 214.

Individual quantum-mechanical entities (quons) need have no well-defined state; they may instead be involved in collective, correlated ('entangled') states with other entities, where only the entire superposition carries information. Peter Knight

Quantum mechanics allows us only one incomplete glimpse of a wavefunction, but if systems can be identically prepared over and over, quantum equivalents of shadows and mirrors can provide the full picture. Dietrich Leibfried, Tilman Pfau and Christopher Monroe, *Physics Today*, April 1998, page 22. The great tragedy of science ... the slaying of a beautiful theory by an ugly fact. T. H. Huxley

The emergence of the classical world, where alternatives do not interfere, from the underlying realm of atomic phenomena, where interference is ubiquitous, is not yet fully understood. Somewhere on the way, coherent quantum superpositions are effectively replaced by incoherent mixtures. Paul Kwiat and Berthold-Georg Englert

Anything you can do in classical physics, we can do better in quantum physics.

Daniel Kleppner

Genuine scientific knowledge cannot be certain, nor can it be justified a priori.

Instead, it must be conjectured, and then tested by experiment, and this requires it to be expressed in a language appropriate for making precise, empirically testable predictions. That language is mathematics. David Deutsch, Artur Ekert, Rossella Lupacchini

But, much as I venerate the name of Newton, I am not obliged to believe that he was infallible. I see, not with exultation, but with regret, that he was liable to err, and that his authority has, perhaps, sometimes even retarded the progress of science. Thomas Young responding to critics of his wave theory of light.

In a sense, the difference between classical and quantum mechanics can be seen to be due to the fact that classical mechanics took too superficial a view of the world: it dealt with appearances. However, quantum mechanics accepts that appearances are the manifestation of a deeper structure (the wavefunction, the amplitude of the state, not the state itself), and that all calculations must be carried out on this substructure. Peter Atkins, *Quanta*, 2nd Ed. page 348

The quantum theory was born in 1900, with the twentieth century, and future centuries will list it among our own's most remarkable achievements. Designed to account for the puzzling behavior of matter at the submicroscopic scale of individual

atoms, the theory has enjoyed phenomenal success. It has accounted in a quantitative way for atomic phenomena with numerical precision never before achieved in any field of science. N. David Mermin

Time is nature's way of keeping everything from happening at once. John Archibald Wheeler

The important thing in science is not so much to obtain new facts as to discover new ways of thinking about them. Willam Lawrence Bragg

After the first world war I gave a great deal of thought to the theory of quanta. It was then that I had a sudden inspiration. Einstein's wave-particle dualism for light was an absolutely general phenomenon extending to all physical nature. de Broglie

In 1900 Planck discovered the blackbody radiation law without using light-quanta. In 1905 Einstein discovered light-quanta without using Planck's law. A. Pais, "Subtle is the Lord" page 358

The human mind treats a new idea the way the body treats a strange protein — it rejects it. Peter Medawar

Electrons are characterized by their entire distributions (called wavefunctions or orbitals) rather than by instantaneous positions and velocities: an electron may be considered always to be (with appropriate probability) at all points of its distribution (which does not vary with time). Frank E. Harris, The Encyclopedia of Physics

There is no space-time inside the atom. Heisenberg

From the quantum mechanical perspective, to measure the position of an electron is not to find out where it is but to cause it to be somewhere. Louisa Gilder, *The Age of Entanglement*

It is usually the fate of a good physical theory that, after its initial success, difficulties or limitations of its applicability become apparent. Eventually it is superseded by a better theory in which some of the difficulties are removed or which has a wider field of application, as the case may be. The history of the quantum theory of radiation, or quantum electrodynamics, is remarkable in showing exactly the opposite trend. W. Heitler

If anything like (classical) mechanics were true then one would never understand the existence of atoms. Evidently there exists another 'quantum mechanics.'
Heisenberg to Pauli in 1925

The more progress physical sciences make, the more they tend to enter the domain of mathematics, which is a kind of centre to which they all converge. We may even judge the degree of perfection to which a science has arrived by the facility with which it may be submitted to calculation. Adolphe Quetelet (1828)

The underlying physical laws necessary for the mathematical theory of a large part of physics and the whole of chemistry are thus completely known, and the difficulty lies only in the fact that the exact application of these laws leads to equations much too complicated to be soluble. P. A. M. Dirac (1929)

Quantum chemistry provides an understanding of the stability and structure of matter, its interaction with electromagnetic radiation, and its chemical and physical transformations. F. Rioux

It seemed to me that the foundation of the work of the mathematical physicist is to get the correct equations, that the interpretation of those equations was only of secondary importance. P. A. M. Dirac

If you are receptive and humble mathematics will lead you by the hand. P. A. M. Dirac

The necessity for a departure from classical mechanics is clearly shown by experimental results. In the first place the forces known in classical electrodynamics are inadequate for the explanation of the remarkable stability of atoms and molecules, which is necessary in order that materials may have any definite physical and chemical properties at all. P. A. M. Dirac, *The Principles of Quantum Mechanics*, 4th Ed., 1958, page 1.

...the main object of physical science is not the provision of pictures, but is the formulation of laws governing phenomena and the application of these laws to the discovery of new phenomena. If a picture exists, so much the better; but whether a picture exists or not is of secondary importance. In the case of atomic phenomena no picture can be expected to exist in the usual sense of the word "picture," by which is meant a model functioning essentially on classical lines. P.A.M. Dirac

In so far as quantum mechanics is correct, chemical questions are problems in applied mathematics. Henry Eyring (1944)

I think there is a moral to this story, namely that it is more important to have beauty in one's equations than to have them fit experiment. It seems that if one is working from the point of view of getting beauty into one's equations, and if one has a really sound insight, one is on a sure line of progress. P. A. M. Dirac (1963)

One could perhaps describe the situation by saying that God is a mathematician of a very high order, and He used very advanced mathematics in constructing the universe. Our feeble attempts at mathematics enable us to understand a bit of the universe, and as we proceed to develop higher and higher mathematics we can hope to understand the universe better. P. A. M. Dirac (1963)

The miracle of the appropriateness of the language of mathematics for the formulation of the laws of physics is a wonderful gift which we neither understand nor deserve. Eugene Wigner (1959)

How can you do both physics and poetry? In physics we try to explain in simple terms something that nobody knew before. In poetry it is the exact opposite. Dirac to Oppenheimer

We have come to the conclusion that what are usually called the advanced parts of quantum mechanics are, in fact, quite simple. The mathematics that is involved is particularly simple, involving algebraic operations and no differential equation or at most only very simple ones. The only problem is that we must jump the gap of no longer being able to describe the behavior in detail of particles in space. Richard Feynman

We choose to examine a phenomenon (the double-slit experiment) that is impossible, absolutely impossible, to explain in any classical way, and which has in it the heart of quantum mechanics. In reality it contains the only mystery. Richard Feynman, The Character of Physical Law.

I will summarize, then, by saying that electrons arrive in lumps, like particles, but the probability of arrival of these lumps is determined as the intensity of waves would be. It is in this sense that the electron behaves sometimes like a particle and

sometimes like a wave. It behaves in two different ways at the same time. Richard Feynman, *The Character of Physical Law* page 138.

We know what goes through the two slits: the wave-function goes through, and then subsequently an electron condenses out of its nebulousness onto the screen behind. N. David Mermin, *Boojums All the Way Through* page 187.

Any other situation in quantum mechanics, it turns out, can be explained by saying, “You remember the case of the experiment with the two holes? It’s the same thing.” Richard Feynman, *The Character of Physical Law* page 130.

Thirty-one years ago, Dick Feynman told me about his ‘sum over histories’ version of quantum mechanics. “The electron does anything it likes,” he said. “It just goes in any direction at any speed, forward or backward in time, however it likes, and then you add up the amplitudes and it gives you the wavefunction.” I said to him, “You’re crazy.” But he isn’t. Freeman Dyson (1980)

One cannot understand ... the universality of the laws of nature, the relationship of things, without an understanding of mathematics. There is no other way to do it. Richard Feynman

I want to talk about the possibility that there is to be an exact simulation, that the computer will do exactly the same as nature. I’m not happy with all the analyses that go with just the classical theory, because nature isn’t classical, dammit. And if you want to make a simulation of nature, you’d better make it quantum mechanical, and, by golly, it’s a wonderful problem because it doesn’t look so easy. Richard Feynman

Quantum simulation is a process in which a quantum computer simulates another quantum system. Because of the various types of quantum weirdness, classical computers can simulate quantum systems only in a clunky, inefficient way. But

because a quantum computer is itself a quantum system, capable of exhibiting the full repertoire of quantum weirdness, it can efficiently simulate other quantum systems. The resulting simulation can be so accurate that the behavior the computer will be indistinguishable from the behavior of the simulated system itself.” (Seth Lloyd, Programming the Universe, p. 149.)

“...the powers of instruction are of very little efficacy except in those happy circumstances in which they are practically superfluous.” Feynman’s Epilogue, The Feynman Lectures on Physics, Volume 3.

The final truth about a phenomenon resides in the mathematical description of it; so long as there is no imperfection in this, our knowledge of the phenomenon is complete. We go beyond mathematical formulas at our own risk; we may find a model or a picture which helps us understand it, but we have no right to expect this, and our failure to find such a model or picture need not indicate that either our reasoning or our knowledge is at fault. The making of models or pictures to explain mathematical formulas and the phenomena they describe is not a step towards, but a step away from, reality; it is like making a graven image of a spirit. Sir James Jeans

The mathematician’s patterns, like the painter’s or the poet’s, must be beautiful; the ideas, like the colours or the words, must fit together in a harmonious way. Beauty is the first test: there is no permanent place in the world for ugly mathematics. G. H. Hardy

In my paper the fact that XY was not equal to YX was very disagreeable to me. I felt this was the only point of difficulty with the hole scheme. Werner Heisenberg

He [de Broglie] has lifted one corner of the great veil. Einstein

I maintain that the cosmic religious feeling is the strongest and noblest motive for scientific research. Einstein

All these fifty years of conscious brooding have brought me no nearer to the question, 'What are light quanta?' Every Tom, Dick, and Harry thinks he knows it, but he is mistaken. Einstein

But the creative principle resides in mathematics. In a certain sense, therefore, I hold it true that pure thought can grasp reality, as the ancients dreamed. Einstein

One may say the eternal mystery of the world is its comprehensibility. Einstein

Speaking of the scientific enterprise Max Planck once said, " Experiments are the only means of knowledge at our disposal. The rest is poetry, imagination."

In sum, it can be said that among the important problems, which are so abundant in modern physics, there is hardly one in which Einstein did not take a position in a remarkable fashion. That he might sometimes have overshot the target in his speculations, as for example in his light-quantum hypothesis, should not be counted against him too much. Because without taking risk from time to time is impossible, even in the most exact natural science, to introduce real innovations. Planck et al. recommending Einstein for membership in the Prussian Academy of Sciences, 1913

I still believe in the possibility of a model of reality, that is to say, of a theory, which represents things themselves and not merely the probability of their occurrence. Einstein

Physics takes its start from everyday experience, which it continues by more subtle means. It remains akin to it, does not transcend it generically; it cannot enter into another realm. Discoveries in physics cannot in themselves - so I believe - have the authority of forcing us to put an end to the habit of picturing the physical world as a reality. Erwin Schrödinger

When two systems, of which we know the states by their respective representatives, enter into temporary physical interaction due to known forces between them, and when after a time of mutual influence the systems separate again, then they can no longer be described in the same way as before, viz. by endowing each of them with a representative of its own. I would not call that one but rather the characteristic trait of quantum mechanics, the one that enforces its entire departure from classical lines of thought. By the interaction the two representatives [the quantum states] have become entangled. Erwin Schrödinger

No language which lends itself to visualizability can describe quantum jumps. Max Born

A new scientific truth does not triumph by convincing its opponents and making them see the light, but rather because its opponents eventually die, and a new generation grows up that is familiar with it. Max Planck (1949)

In conclusion, I would like to emphasize my belief that the era of computing chemists, when hundreds if not thousands of chemists will go to the computing machine instead of the laboratory, for increasingly many facets of chemical information, is already at hand. There is only one obstacle, namely, that someone must pay for the computing time. Robert S. Mulliken (1966)

Today, the situation has been reached where, in many cases, the computational chemist can substitute the computing machine for the test tube. Not that the computational approach to the study of chemistry should be regarded as a rival to the traditional experimental techniques. Often the two approaches are complementary, one approach providing data which are not available from the other, and vice versa. Stephen Wilson (1986)

Numerical simulation is now becoming a trusted partner with experiment. Simulations ... can replace experiments [that] cannot be done because of cost or experimental difficulty. D. A. Dixon (1989)

Something unknown is doing we don't know what. Sir Arthur Eddington

In quantum mechanics there is no such concept as the path of a particle. Landau and Lifshitz

If we ask, for instance, whether the position of the electron remains the same, we must say "no"; if we ask whether the electron's position changes with time, we must say "no"; if we ask whether the electron is at rest, we must say "no"; if we ask whether it is in motion, we must say "no." J. Robert Oppenheimer

This belief in an external world independent of the perceiving subject is the basis of all natural science. Einstein

And since none of the other 'interpretations' of quantum mechanics that we have looked at has brought us any real peace of mind, they simply push the weirdness around, from one place to another, but cannot make it go away - let us stick with the Copenhagen interpretation, which has the virtues of simplicity and necessity. It

takes quantum mechanics seriously, takes its weird aspects at face value, and provides an economical, austere, perhaps even antiseptic, account of them. David Lindley, *Where Does the Weirdness Go?* p. 164

That one body may act upon another at a distance through a vacuum without the mediation of anything else ... is to me so great an absurdity, that I believe no man, who has in philosophical matters a competent faculty for thinking, can ever fall into.
Newton

A philosopher once said, "It is necessary for the very existence of science that the same conditions always produce the same results." Well they don't! Richard Feynman

If your model contradicts quantum mechanics, abandon it! Richard Feynman

Quantum mechanics is not just a good idea, it's the Law!

We have always had a great deal of difficulty understanding the world view that quantum mechanics represents. At least I do, because I'm an old enough man that I haven't got to the point that this stuff is obvious to me. Okay, I still get nervous with it ... You know how it always is every new idea, it takes a generation or two until it becomes obvious that there's no real problem. I cannot define the real problem, therefore I suspect that there is no real problem, but I'm not sure there's no real problem. Richard Feynman

In our description of nature the purpose is not to disclose the real essence of the phenomena but only to track down, as far as possible, relations between the manifold aspects of our experience. Niels Bohr

Physics is to be regarded not so much as the study of something given a priori, but rather as the development of methods for ordering and surveying human experience.

Niels Bohr

The mathematical predictions of quantum mechanics yield results that are in agreement with experimental findings. That is the reason we use quantum theory. That quantum theory fits experiment is what validates the theory, but why experiment should give such peculiar results is a mystery. This is the shock to which Bohr referred. Marvin Chester with slight modifications.

To our classical sensibilities, the phenomena of quantum mechanics - interference, entanglement, nonlocal correlations, and so forth - seem weird. The various formulations package that weirdness in various ways, but none of them can eliminate it because the weirdness comes from the facts, not the formalism. Daniel Styer, et al. *Amer. J. Phys.* 70, 297, (2002).

When asked whether the algorithm of quantum mechanics could be considered as somehow mirroring an underlying quantum world, Bohr would answer, "There is no quantum world. There is only an abstract quantum physical description. It is wrong to think that the task of physics is to find out how nature is. Physics concerns what we can say about nature."

In our description of nature the purpose is not to disclose the real essence of the phenomena but only to track down, so far as possible, relations between the manifold aspects of our experience. Niels Bohr

My starting point (for the development of the Bohr model) was not at all the idea that an atom is a small-scale planetary system and as such governed by the laws of astronomy. I never took things as literally as that. My starting point was rather the

stability of matter, a pure miracle when considered from the standpoint of classical physics. Niels Bohr

Once at the end of a colloquium I heard Debye saying something like: “Schrödinger, you are not working right now on very important problems...why don't you tell us some time about that thesis of de Broglie, which seems to have attracted some attention?” So in one of the next colloquia, Schrödinger gave a beautifully clear account of how de Broglie associated a wave with a particle, and how he could obtain the quantization rules by demanding that an integer number of waves should be fitted along a stationary orbit. When he had finished, Debye casually remarked that he thought this way of talking was rather childish ... To deal properly with waves, one had to have a wave equation. Felix Bloch (1976)

Observations not only disturb what has to be measured, they produce it... We compel the electron to assume a definite position... We ourselves produce the result of the experiment. Jordan

Quantum mechanics is certainly imposing. But an inner voice tells me that it is not yet the real thing. The theory says a lot, but does not really bring us any closer to the secret of the 'old one.' I, at any rate, am convinced that He is not playing at dice. Einstein

If God has made the world a perfect mechanism, He has at least conceded so much to our imperfect intellect that in order to predict little parts of it, we need not solve innumerable differential equations, but can use dice with fair success. Max Born

It seems hard to look at God's cards. But I cannot for a moment believe that he plays dice and makes use of 'telepathic' means as the current quantum theory alleges He does. Einstein

I cannot believe in the (quantum) theory because it cannot be reconciled with the idea that physics should represent a reality in time and space, free from spooky actions at a distance. Einstein

The Heisenberg-Bohr tranquilizing philosophy - or religion? - is so delicately contrived that, for the time being, it provides a gentle pillow for the true believer from which he cannot very easily be aroused. Einstein

The more success the quantum theory has the sillier it looks. Einstein (1912)

There appears to me one grave difficulty in your hypothesis, which I have no doubt you fully realize, namely, how does an electron decide what frequency it is going to vibrate at when it passes from one stationary state to the other? It seems to me that you would have to assume that the electron knows beforehand where it is going to stop. Ernest Rutherford (1913)

I am a professional theoretical physicist and I would like to make a clean theory. And when I look at quantum mechanics I see a dirty theory. John Bell

We conclude then that no theory of mechanically determined hidden variables can lead to all of the results of the quantum theory. David Bohm, *Quantum Theory*, 1951, page 623.

But if (a hidden-value theory) is local it will not agree with quantum mechanics, and if it agrees with quantum mechanics it will not be local. This is what the theorem says. John Bell

In principle, quantum chemistry enables us to calculate bond energies, dissociation energies, ionization potentials, electron affinities, frequencies and intensities of spectral transitions, electron densities, spin densities, dipole moments,

polarizabilities, equilibrium internuclear distances, force constants, potential barriers for internal rotations, basicity constants, and many other properties of molecules, ions, and atoms without knowledge of empirical data of these systems. It is further possible to treat intermolecular forces and chemical reactions. W.

Kutzelnigg

I want to know how God created this world. I am not interested in this or that phenomenon, in the spectrum of this or that element. I want to know his thoughts, the rest are details. Einstein

The essential point in science is not a complicated mathematical formalism or a ritualized experimentation. Rather the heart of science is a kind of shrewd honesty that springs from really wanting to know what the hell is going on! Saul-Paul Sirag

On a paper submitted by a physicist colleague, Wolfgang Pauli had the following comment: "This isn't right. This isn't even wrong."

It is also a good rule not to put too much confidence in observational results that have been put forward until they are confirmed by theory. Sir Arthur Eddington

When theory and experiment agree, that is the time to be especially suspicious. Niels Bohr

The fact that all past futures have resembled past pasts does not guarantee that all future futures will resemble future pasts. Max Jammer

The classical tradition has been to consider the world to be an association of observable objects (particles, fluids, fields, etc.) moving according to definite laws of force, so that one could form a mental picture in space and time of the whole scheme. This led to a physics whose aim was to make assumptions about the

mechanism and forces connecting these observable objects in the simplest possible way. It has become increasingly evident in recent times, however, that nature works on a different plan. Her fundamental laws do not govern the world as it appears in our mental picture in any very direct way, but instead they control a substratum of which we cannot form a mental picture without introducing irrelevancies. P.A.M. Dirac

You surely must understand, Bohr, that the whole idea of quantum jumps necessarily leads to nonsense... If we are going to have to put up with these damn quantum jumps, I am sorry that I ever had anything to do with quantum theory. Schrödinger

If an experiment does not hold out the possibility of causing one to revise one's views, it is hard to see why it should be done at all. P. B. Medawar

The human mind treats a new idea the way the body treats a strange protein — it rejects it. P. B. Medawar

The distinction between - and the formal separateness of - the creative and the critical components of scientific thinking is shown up by logical dissection, but it is far from obvious in practice because the two work in rapid reciprocation of guesswork and checkwork, proposal and disposal, Conjecture and Refutation. Peter Medawar

The formalism of the quantum theory leads to results that agree with experiment with great accuracy and covers an extremely wide range of phenomena. As yet there are no experimental indications of any domain in which it might break down. Nevertheless, there still remain a number of basic questions concerning its fundamental significance which are obscure and confused. Thus for example one of

the leading physicists of our time, M. Gell-Mann, has said “Quantum mechanics, that mysterious, confusing discipline, which none of us really understands but which we know how to use.” Bohm and Hiley

Quantum mechanics is not itself a theory; rather it is the framework into which all contemporary physical theory must fit. Murray Gell-Mann

This theoretical failure to find a plausible alternative to quantum mechanics... suggests to me that quantum mechanics is the way it is because any small change in quantum mechanics would lead to logical absurdities. If this is true, quantum mechanics may be a permanent part of physics. Indeed, quantum mechanics may survive not merely as an approximation to a deeper truth, in the way that Newton’s theory of gravitation survives as an approximation to Einstein’s general theory of relativity, but as a precisely valid feature of the final theory. Steven Weinberg

... the more accurate the calculations became, the more the concepts tended to vanish into thin air. R. S. Mulliken, J. Chem. Phys. 43, S2 (1965)

“For calculating molecular properties, quantum chemistry seems to be the obvious tool to use. Calculations that do not use the Schrödinger equation are acceptable only to the extent that they reproduce the results of high level quantum mechanical calculations.” (U. Burkert & N.L. Allinger, “Molecular Mechanics”, 1982)

The essential difference between classical mechanics and quantum mechanics is that in classical mechanics the kinetic energy and the potential energy are independent (one is determined by momentum, the other by position), whereas in quantum mechanics “ \bar{T} and \bar{V} are simultaneously determined by the wavefunction,” with the kinetic energy proportional to the average square of the

gradient of the amplitude function. It is the balance of trying to find a wavefunction leading to both the lowest \bar{T} and the lowest \bar{V} that is responsible for the stability of quantum mechanical atoms. Goddard

Finally, it should be emphasized that the phenomenon of the eigenstate is intimately related to the fact that molecules are subject to the laws of quantum mechanics; there are no ground states in classical mechanics or electrostatics. Consequently a physical picture seeking to describe chemical bonding must necessarily incorporate features which distinguish quantum mechanics from classical mechanics and electrostatics... It may be added that the existence of a ground state is intrinsically connected with the fact that the variation integral contains both kinetic and potential energy... Omission of one or the other from consideration cannot, therefore, lead to a full interpretation of binding. Ruedenberg

The chemical bond is a highly complex phenomenon which eludes all attempts at simple description. Werner Kutzelnigg

Because atomic behavior is so unlike ordinary experience, it is very difficult to get used to, and it appears peculiar and mysterious to everyone - both to the novice and to the experienced physicist. Even the experts do not understand it the way they would like to, and it is perfectly reasonable that they should not, because all of direct, human experience and of human intuition applies to large objects. We know how large objects will act, but things on a small scale just do not act that way. So we have to learn about them in a sort of abstract or imaginative fashion and not by connection with our direct experience... We would like to emphasize a very important difference between classical and quantum mechanics. We have been talking about the probability that an electron will arrive in a given circumstance. We have implied that in our experimental arrangement (or even in the best possible one) it would be impossible to predict exactly what would happen. We can only predict the odds! This

would mean, if it were true, that physics has given up on the problem of trying to predict exactly what will happen in a definite circumstance. Yes! physics has given up. We do not know how to predict what would happen in a given circumstance, and we believe now that it is impossible - that the only thing that can be predicted is the probability of different events. It must be recognized that this is a retrenchment in our earlier ideal of understanding nature. It may be a backward step, but no one has seen a way to avoid it... So at the present time we must limit ourselves to computing probabilities. We say "at the present time," but we suspect very strongly that it is something that will be with us forever - that it is impossible to beat that puzzle - that this is the way nature really is. Richard P. Feynman, Robert B. Leighton, and Matthew Sands

If a theory is complicated, its wrong. Feynman

At every instant a grain of sand has a definite position and velocity. This is not the case with an electron. Max Born

I have an old belief that a good observer really means a good theorist. Charles Darwin (1860)

About thirty years ago there was much talk that geologists ought only to observe and not theorize; and I well remember someone saying that at this rate a man might as well go into a gravel-pit and count the pebbles and describe the colours. How odd it is that anyone should not see that all observation must be for or against some view if it is to be of any service. Charles Darwin (1861)

Scientific reasoning is an explanatory dialogue that can always be resolved into two voices or episodes of thought, imaginative and critical, which alternate and interact. Peter Medawar

Science is no more a classified inventory of factual information than history is a chronology of dates. Peter Medawar

The process of scientific discovery is cautious and rigorous, not by abstaining from hypotheses, but by rigorously comparing hypotheses with facts, and resolutely rejecting all which the comparison does not confirm. William Whewell

There is a mask of theory over the whole face of nature. William Whewell

The progress of science is strewn, like an ancient desert trail, with the bleached skeletons of discarded theories which once seemed to possess eternal life. A. Koestler

Do not allow yourselves to be misled by the common notion that a hypothesis is untrustworthy merely because it is a hypothesis. T. H. Huxley

Take away number in all things and all things perish. Take calculation from the world and all is enveloped in dark ignorance, nor can he who does not know the way to reckon be distinguished from the rest of the animals. St. Isidore of Seville

Mathematics is the language in which the gods speak to people. Plato

The principles of physics, as far as I can see, do not speak against the possibility of maneuvering things atom by atom. It is not an attempt to violate any laws; it is something in principle that can be done, but has not been done because we are too big. Richard P. Feynman December 29, 1959.

We throw the dice. It is up to the Lord to fix how they fall. Proverbs 16:33

Licensed **CC-BY-4.0** (<https://creativecommons.org/licenses/by/4.0/>).

Original source: Constant Contact campaign

Markdown source: <https://jedanderson.org/posts/where-there-is-magic.md> (<https://jedanderson.org/posts/where-there-is-magic.md>).

Source on GitHub: [/src/content/posts/where-there-is-magic.md](https://github.com/jedanderson432/jedanderson-site/blob/main/src/content/posts/where-there-is-magic.md) (<https://github.com/jedanderson432/jedanderson-site/blob/main/src/content/posts/where-there-is-magic.md>).